

CONTROLLER

INSTANTANEOUS FLOW CONTROL INDICATOR

MEC100PM Series Operation Manual

> For use in FLC700 Series <

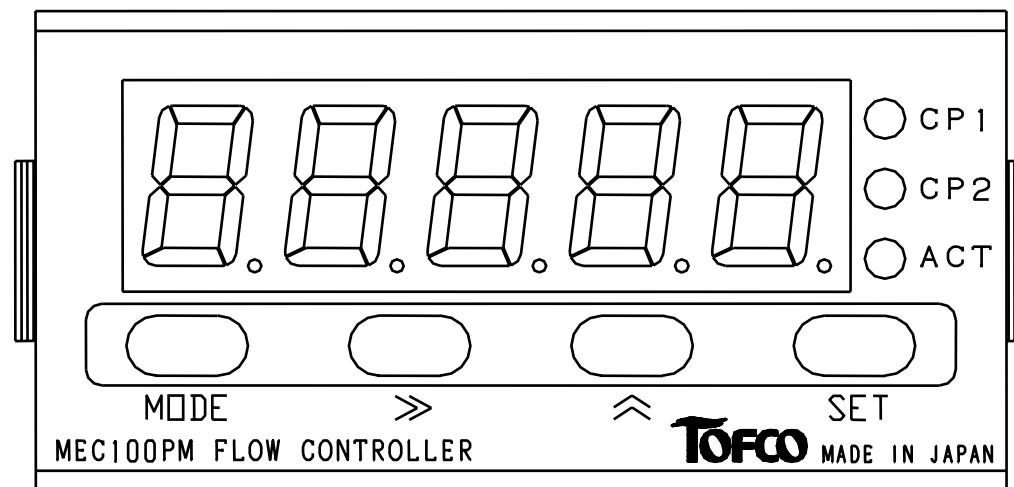

Warning This Manual contains important instructions about the proper and safety use of the product. Before using, please read thoroughly, and be sure to observe them.

- ① Never use this product in such main loop control systems as medical equipment which has a direct effect on the human lives, space instrumentation, atomic power control machine, marine vessel and the chemical apparatus for the military purpose kept "Export Trade Control Ordinance" under control.
- ② A great care should be taken not to exceed the rated power supply(24VDC±10%). The wiring service should be done, after turning off power. If not, it may cause malfunction, damage to the devices or fire.
- ③ Avoid using the Controller in the following locations. If not, it may cause danger of life posed by fire and explosion, and damage to the device.
 - In locations where the corrosive gases and flammable gases will occur.
 - In locations where water and oil splash and where much dust and metal powder are produced, and where are too saline.
 - In locations where are subjected to the direct rays of the sun and where exceeds ambient temperature between 0°C and 55°C.
 - In locations where are damp and the condensation of humidity will occur due to the abrupt change of temperature.
 - In locations where are caused by a great vibration and impact shock.
 - In locations where are near to such devices as producing a strong electromagnetic noise and high-frequency noise.

Precaution before use (Input/output signal lines)

- ① Make sure that there are no miswirings. If not, it may cause damage to the internal parts.
- ② Avoid wiring together with such strong noise sources as power line, relay, electromagnetic valve and solenoid operated valve. If not, it may cause malfunction triggered by induction.

We highly appreciate your purchasing the "MEC100MP Series Instantaneous Flow Control Indicator". Before use, please read this Operation Manual with caution to achieve peak performance of the product and to ensure safety operation.

【Major features】



- ① The Controller can be used as an instantaneous flow control indicator in combination with the Flow Control Valve.
- ② Not alone through the input of the pulse signal coming from the flowsensor built-in the flow Control Valve it enables to control the instantaneous flowrate and instantaneous flow display, but taking advantage of the two staged comparative output functions, it can generate the alarm at upper / lower limits, lower / lower limits and upper / upper limits.
- ③ The change of the setting flowrate can be made from outside by using an analog input signal. The proportionate analog value of 4-20mA is a standard, but 0-5V or 1-5V is available). Also at the time when setting the parameter(Local mode), the change of the flow setting value can be made on the screen display.
- ④ The instantaneous flowrates during the ongoing measurement can be generated to the outside. the setting flowrate can be made from outside by using analog input signal. (The proportionate analog value of 4-20mA is a standard, but 0-5V or 1-5V is available).
- ⑤ The setting of the conditions necessary for the operation can all be easily operated by the key switch on the front panel.
- ⑥ The Controller is driven at 24VDC(D.C. voltage).
- ⑦ The driving power supply to the outside is supplied through the Controller side.
- ⑧ The initial setting conditions have been stored for about ten years by EEPROM at the time of power failure.
- ⑨ Outside dimensions are 24(H) x 48(W) 【DIN type】





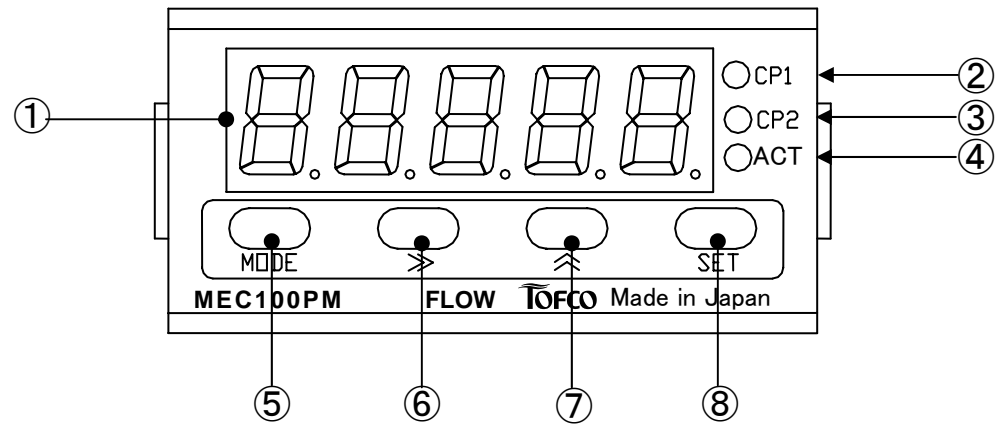

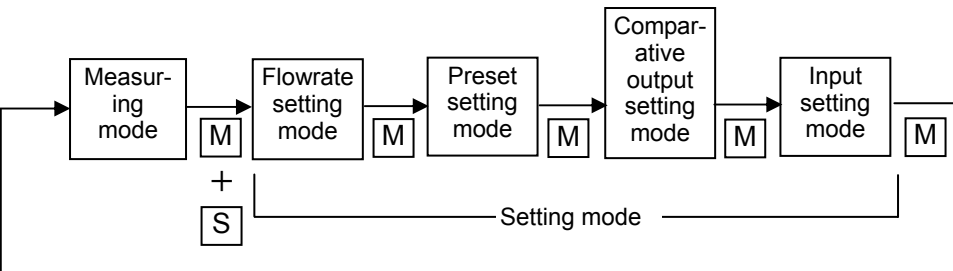

Contents

Explanations for display unit and their operational keys	2
Explanations for each parameter	3
Setting loop of the functions	9
Function of error display	14
Trouble shooting (If appeared to have failed,)	14
Explanations for external input/output pins	15
Wiring	16
Dimensions for panel cut-out	17
Specifications	18
Warranty	20

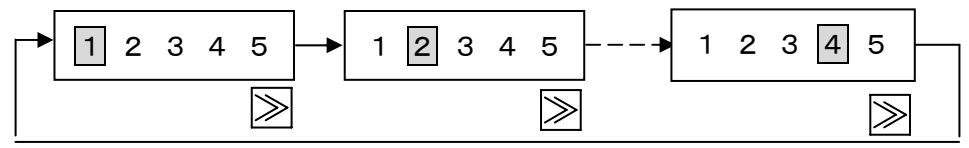
Explanations for display unit and their operational keys

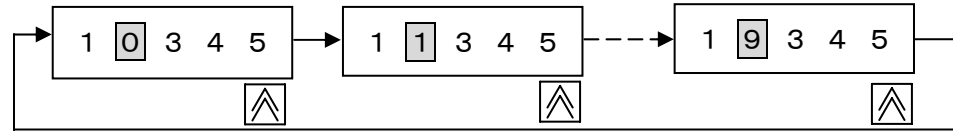

Names of functional keys	Functional contents
④ Display of measured value	<p>At the time of measuring: It displays measured values (Instantaneous flowrates) and also displays input signal values and comparative output setting values on the monitor display by operating keys.</p> <p>At the time of setting: It displays setting menu and parameters.</p> <p>Others: It displays error messages on hardware and wrong setting.</p>
⑤ CP 1 on indicator	LED will light up, when comparative output is turned ON. (LED will light up, when relay contact is closed.)
⑥ CP 2 on indicator	LED will light up, when comparative output is turned ON. (LED will light up, when relay contact is closed.)
⑦ ACT on indicator	<p>It indicates the detecting conditions of the flowsensor in the LED lighting interval.</p> <ul style="list-style-type: none"> • LED will light up at slow interval, when flowrate is decreased. • LED will light up at faster interval, when flowrate is increased.
⑧ Mode key 	<p>It changes over from measuring mode to setting mode in conjunction with  key, and also changes over mode within the setting mode.</p> 

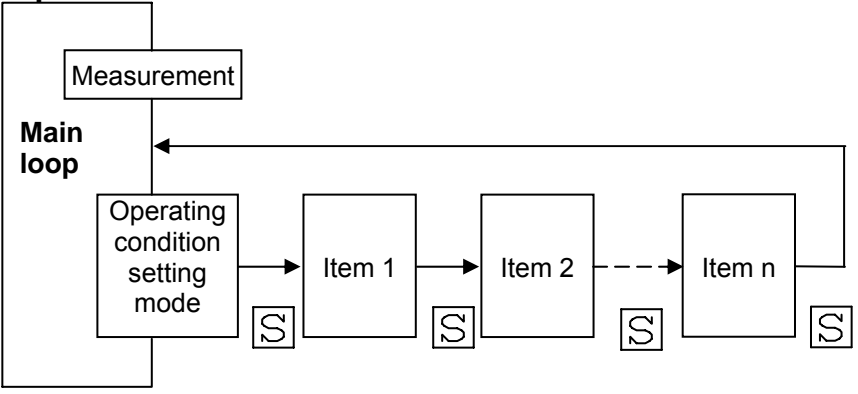
Names of functional keys	Functional contents
① Shift key 	<p>It performs the digit shift of the numerical value to be set. Select the digit to be set by using  key.</p> 
② Up key 	<p>It changes over setting contents and changes numerical values to be set. Select the digit to be set by using  key, and set it by using  key.</p> <p>When setting the numerical values, the digit to be set will blink, and by pressing  key the numerical value which has been blinking operates incremental operation.</p> 
③ Set key 	<p>It changes over setting items within setting mode. Data and items which have been set are set by  key.</p> <p>(For example)</p> 

Explanation for each parameter

On-screen display	Items	Setting contents	Setting ranges	Initial values
FLCP	Setting of the setting value in flowrate			
CP 1_H or L	Setting of comparative value on CP1	The value on CP1 in comparative output is set.	000.00 – 050.00 / 0000.0 – 0100.0	
CP 2_H or L	Setting of comparative value on CP2	The value on CP2 in comparative output is set.	000.00 – 050.00 / 0000.0 – 0100.0	
PS. SEt	Setting of the preset value			
PS — 1 d	PS value 1	The value of PS 1 in the preset is set.	000.00 – 050.00 / 0000.0 – 0100.0	
PS — 2 d	PS value 2	The value of PS 2 in the preset is set.	000.00 – 050.00 / 0000.0 – 0100.0	
PS — 3 d	PS value 3	The value of PS 3 in the preset is set.	000.00 – 050.00 / 0000.0 – 0100.0	
SEL. PS	Selection of preset operation mode	The preset operation mode is selected.(For more details, see separate sheet.)	P. St. – 0 – 3	P. St. – 2
AO. trG	Setting of valve fully closing conditions	The valve fully closing conditions are selected. (For more details, see separate sheet.)	trG. – 0 – 3	trG. – 3
SCALE	Setting of scaling			
SP d. d P	Setting of decimal point position in the indicated values	The decimal point position in the indicated values of instantaneous flowrate is set.	(50 L type) Any value other than 999.99 should not be set.	999.99
			(100 L type) Any value other than 9999.9 should not be set.	9999.9
Lo. SCL	Setting of LOW scale at input	The flowrate at LOW side of analog output is set. (Ordinarily either 00. 000 or 000. 00 is inputted.)	000.00 (50 L type)	000.00
			0000.0 (100 L type)	0000.0
Hi. SCL	Setting of High scale at input	The flowrate at High side of analog output is set. (Ordinarily max. flowrate inputted)	000.00 – 050.00 / 0000.0 – 0100.0	Maximum flowrate
AvrG.F	Setting of number of times in moving average	The setting is made for the purpose of stabilizing the display. (Working with AVrG.C) ※It functions to restrain from fluctuations of instantaneous value display caused by those of input signal by taking the arithmetic average between the past n times and the measured values this time.	0 – 30	20
Lo. Cut	Setting of low cut on display	It functions to restrain from error on display in the side of low flowrate. (Ordinarily 00. 000 is inputted.)	000.00 – 050.00 / 0000.0 – 0100.0	00. 000(5L/10L)
				000. 00(20L/30L)
CP. COF	Setting of comparative condition			

On-screen display	Items	Setting contents	Setting ranges	Initial values
C P1. H. L	Setting of upper/lower limits on CP 1	The operating condition on CP 1 in the comparative output is selected. H : At the time of setting input value \geq comparative value, output is ON. L : At the time of setting input value \leq comparative value, output is ON.	Either H or L	
1 - H y s	Setting of hysteresis on CP 1	It functions to prevent the comparative output from chattering. (Input is the value of flowrate)	000.00 - 050.00 / 0000.0 - 0100.0	000.10 or 0001.0
1 . C. d L y	Setting of delay on CP 1	It functions to allow the operation of the comparative output to delay. (Units of input is s e c.)	Either O N or O F F 00. 000 - 20. 000 (At the time of ON)	O F F
C P2. H. L	Setting of upper/lower limits on CP 2	The operating condition on CP 2 in the comparative output is selected. H : At the time of setting input value \geq comparative value, output is ON. L : At the time of setting input value \leq comparative value, output is ON.	Either H or L	
2 - H y s	Setting of hysteresis on CP 2	It functions to prevent the comparative output from chattering. (Input is the value of flowrate)	000.00 - 050.00 / 0000.0 - 0100.0	000.10 or 0001.0
2 . C. d L y	Setting of delay on CP 2	It functions to allow the operation of the comparative output to delay. (Units of input is s e c.)	Either O N or O F F 00. 000 - 20. 000 (At the time of ON)	O F F
S C L. E t	Setting of scaling at analog input			
I n. S E L	Selection of analog inputs	The forms of analog inputs are selected. A. 4 - 20 : Analog input at 4-20mA V. 1 - 5 : Analog input either at 0 - 5V or 1 - 5V (Decided when purchasing)	Either A. 4 - 20 or V. 1 - 5	A. 4 - 20 (Standard)
S C L. 0 4	Setting of LOW scale at input	The flowrate at LOW side of analog input is set.(Ordinarily either 00. 000 or 000. 00 is inputted.)	000.00 - 050.00 / 0000.0 - 0100.0	000.00 (50 L) 0000.0 (100 L)
S C L. 2 0	Setting of H i g h scale at input	The flowrate at H i g h side of analog input is set. (Ordinarily max. flowrate is inputted)	000.00 - 050.00 / 0000.0 - 0100.0	Maximum flowrate
A v r G. A	Setting of number of times in moving average at analog input	The setting is made for the purpose of stabilizing the input signal. ※It functions to restrain from fluctuations of input signal by taking the arithmetic average between the past n times and the measured values this time.	0 - 30	20
d s p l y	Setting of display condition			
F. - d s p.	Selection of display	The items in the display condition are selected. r t. F L o : Measured flowrate display t G. F L o : Setting flowrate display E t. - I n : Opening command display (It displays only at the time of valve opening commande control.) r. t h r n : Measuring temperature display (Due to preparation, it cannot be used.) t. t h r n : Setting temperature display (Due to preparation, it cannot be used.)	r t. F L o t G. F L o E t. - I n	r t. F L o
d S P. r t	Setting of display timing time	The time to update the display is set. (Unit is sec.)	00. 1 - 30. 0	0 1. 0
A V r G. d	Setting of the number of times in display moving average	The setting is made for the purpose of stabilizing the display. (Working with A v r G. F) ※It functions to restrain from fluctuations of input signal by taking the arithmetic average between the past n times and the measured values this time.	0 - 30	20
0. - S U P.	Setting of zero suppression	It selects use or nonuse of zero suppression function. If the setting is made effective, the higher-order zero than decimal point is not made to display on the display.	O N : Use O F F : Nonuse	O N
O P. F L	Setting of operating condition			

On-screen display	Items	Setting contents	Setting ranges	Initial values
H y S c. H	Setting of dead zone value at upper limit	It functions to restrain the valve from operating very often more than necessary. (Unit is the flowrate.) If the setting flowrate is within the dead zone ranges of the upper limit side on the basis of the setting flowrate, the valve is not made to operate, and if making the numeral value larger, it can conserve energy and improve durability of the valve. (Input the values more than 1% for the max flowrate.) ※ Input numeral value as large as possible.	000.00 – 050.00 / 0000.0 – 0100.0	Value more than 1% for the max. flowrate
H y S c. L	Setting of dead zone value at lower limit	It functions to restrain the valve from operating very often more than necessary. (Unit is the flowrate.) If the setting flowrate is within the dead zone ranges of the lower limit side on the basis of the setting flowrate, the valve is not made to operate, and if making the numeral value larger, it can conserve energy and improve durability of the valve. (Input the values more than 1% for the max flowrate.) ※ Input numeral value as large as possible.	000.00 – 050.00 / 0000.0 – 0100.0	Value more than 1% for the max. flowrate
c t. d L y	Setting of control delay	If deviated the dead zone from setting flowrate, it starts operating, but makes the operation delay and functions to conserve energy and improve durability of the valve. Unit is sec. (If temporarily deviated from the dead zone, it does not allow the valve to operate within a certain time.)	00000 – 30000	00000
t t. A v r	Setting of time to average flowrates	Due to preparation it cannot be functioned.		
F L o. – H	Setting of max. value of flowrate	The maximum value of flowrate is inputted.	000.00 – 050.00 / 0000.0 – 0100.0	Value of max flowrate
F r. – I n	Setting of max frequency	The max value of the flowsensor's frequency is inputted. (Frequency at the time of the max flowrate is inputted in term of Hz.)	000. 0 – 300. 0	Max value of frequency
P. S t P. A	Setting of max stepping on motor	The max. distance on stepping motor is set. (Effective only when it controls the valve opening command control.)	Do not set any value other than 3200	3200
P. S t P. n	Setting of minimum stepping on motor	It sets the minimum distance on stepping motor. (Effective only when it controls the valve opening directive control.)	Do not set any value other than 00000.	00000
P u n. – L	Setting of current value at the waiting time of motor	Current value at the waiting time of motor is set. (Do not set any values other than the initial setting value.)	Do not set any value other than 016.	016
P u n. – H	Setting of current value when motor moves.	Current value is set when motor moves. (Do not set any values other than the initial setting value.)	Do not set any value other than 154.	154
n P. S P d.	Setting of moving velocity on motor	The moving velocity of motor is set. (Do not set any values other than the initial setting value.)	Do not any value other than 0600.	0600
C n t. A r.	Setting of the control direction	The control direction is set. A . –P o S : Direct action (It should be normally used in this setting.) A . –n E G : Reverse action	A . –P o S or A . –n E G	A . –P o S
A. – O u t	Setting of scaling for analog output			
S L. O u t	Setting of analog output	Analog output form is set. C u r. E t : Current output (4 – 20 mA) V o L t o : Voltage output (Either 0 – 5 V or 1 – 5 V)	Either C u r. E t or V o L t o.	C u r. E t
C A L. L o	Calibration of analog L o w output	Analog L o w output is calibrated. (Since it has been configured at factory shipment, do not adjust any.)	0000 – 4095.	

On-screen display	Items	Setting contents	Setting ranges	Initial values
CAL.HI	Calibration of analog High output	Analog High output is calibrated. (Since it has been configured at factory shipment, do not adjust any.)	0000 – 4095.	
A.SEL.E	Selection of analog output	Due to preparation do not set any other than the r t. F L o.	r t. F L o C u t. F t	r t. F L o
o P. C o	Setting of control condition			
Prot.	Protection of key	It functions so as to be unable to change the setting value of each parameter. If trying changing again after turned on the protection, it is possible only if turning off this mode.	Either ON or OFF	OFF
Av t. - P	Setting of value in proportional coefficient	The value of proportional coefficient(P) is inputted. (Use at the initial value ordinarily.)	0. 10 – 100. 00	0 0. 5 0
Av t. - I	Setting of value in integral coefficient	The value of integral coefficient (I) is inputted. (Use at the initial value ordinarily.) (The numeral value varies according to the value of D in the pulse motor type. It has no relationship with the indicated value.)	0. 10 – 100. 00	0 0. 5 0
Av t. - d	Setting of value in differential coefficient	It inputs the differential coefficient (D). (Use at initial value ordinarily.)	0. 10 – 100. 00	0 0. 3 0
Ab h t. n	Setting of breast time	The breast time is set. (It allows for the slow and steady control.) (Use at the initial value ordinarily.)	00. 01 – 99. 99	0 0 8 0 0
C n t. I	Selection of operation mode	The operation mode to the outside command is selected. P A r A : Setting of parameter (Setting of display screen on local mode) C. 4 – 2 0 : Setting of analog input (0 – 5 V, 1 – 5 V and 4 – 20 mA) r A t i o : Valve opening command (Used at the time when controlling the valve opening)	P A r A C. 4 – 2 0 r A t i o	P A r A
S E L. S r	Selection of sensor input	The type of flowsensor is selected. P U L S E: Pulse A. 4 – 2 0 : Analog 4 – 2 0 mA (0 – 5 V and 1 – 5 V are selected in the same manner.)	P U L S E A. 4 – 2 0	P U L S E

Particulars about how to operate

Operation	Display	Contents	Remarks
Operation mode (C n t . I)	※ P A r A	Operation mode of parameters	Setting of flowrate is made on instruction panel, and the values are controlled as a targeting value.
	C. 4 – 2 0	Operation mode for analog input (Standard: 4 – 2 0 mA)	Setting of flowrate is made in terms of external analog input, and the values are controlled as a targeting value.
	r A t i o	Valve opening degree command mode (Standard: 4 – 2 0 mA)	Setting of valve opening is made in terms of external analog input, and the opening values are controlled.
Sensor input (S E L . S r)	P U L S E	Selection is made when the flowsensor is a type of pulse.	
	A. 4 – 2 0	Selection is made either when flowsensor is a type of analog (Standard: 4-20mA) or when it is in the valve opening command mode.	
Preset command	P S . S E t	Only turning ON/OFF the external contact enable to change the setting values of flowrates and to turn on/off the control. (Note: Provided it functions only when it is in the parameter operation mode, but not functions in any other mode.)	Maximum four kinds of setting in the flowrates can be made. For more detailed information, see the following items.

※” rAtio” function does not correspond in this FLC700 Series.

Particulars about preset command mode

Operation mode	Preset terminal 1	Preset terminal 2	Particulars
P. S t. – 0	Temporarily turning ON/OFF the full closing (At the time of setting trG. –1 or – 3)	Turning ON/OFF control	If turned ON preset terminal 1 and 2 at same time, preset terminal 2 is prevailed. (What is closed fully temporarily means to close the valve temporarily, and to return to the ordinary control of operation immediately after that. It is used for tentatively checking if the valve operates properly. A full closing cannot be held in this operation.)
P. S t. – 1	P S value 1	Turning O N / O F F control	If turned ON preset terminal 1 and 2 at same time, preset terminal 2 is prevailed.
P. S t. – 2	P S value 1	P S value 2	If turned ON preset terminal 1 and 2 at same time, preset terminal 2 is prevailed.
P. S t. – 3	O F F	O F F	Parameter setting value (Instruction panel setting value)
	O N	O F F	P S value 1
	O F F	O N	P S value 2
	O N	O N	P S value 3

※ if necessary to hold the full closing, set the PS value to 0 L.

Particulars about the setting of valve fully closing conditions

Operation mode	Valve fully closing operation
t r G. – 0	A full closing function is in OFF position.
t r G. – 1	When preset terminal 1 is turned on, a full closing function is performed temporarily (Preset operation mode is performed only when P. S t. – 0. is set)
t r G. – 2	When the flowrate has been set by external analog input (4-20mA, etc.), and when it entered into around 0 L input, a full closing function is performed.
t r G. – 3	When preset terminal 1 is turned on, a full closing function is performed temporarily (Preset operation mode is performed only when P. S t. – 0. is set) or when the flowrate has been set by external analog input (4-20mA, etc.), and when it entered into around 0 L input, a full closing function is performed.

1. When setting the parameter values, or setting the PS values to 0 L, the valve is unconditionally closed fully and held. (The valve is closed until after the water has been stopped and will hold.)
2. If trying holding the full closing while using the preset terminal, select both of the P. S t. – 1 to 3 (Preset command) and the t r G. – 2 to 3 (Valve fully closing).
3. If trying closing the valve fully at the time the setting values come to around 0 L in the analog input, select the t r G. – 2 to 3.
4. When the full closing conditions are satisfied, and the valve is in operation to the full closing direction, the “b A S I C “ is displayed, but it is not an error display.

Setting loop of functions

To move from the measurement mode to the setting mode, Hold **M** key and press **S** key. **M** key is used for moving the main loop, and **S** key is for the use in the step to each item.

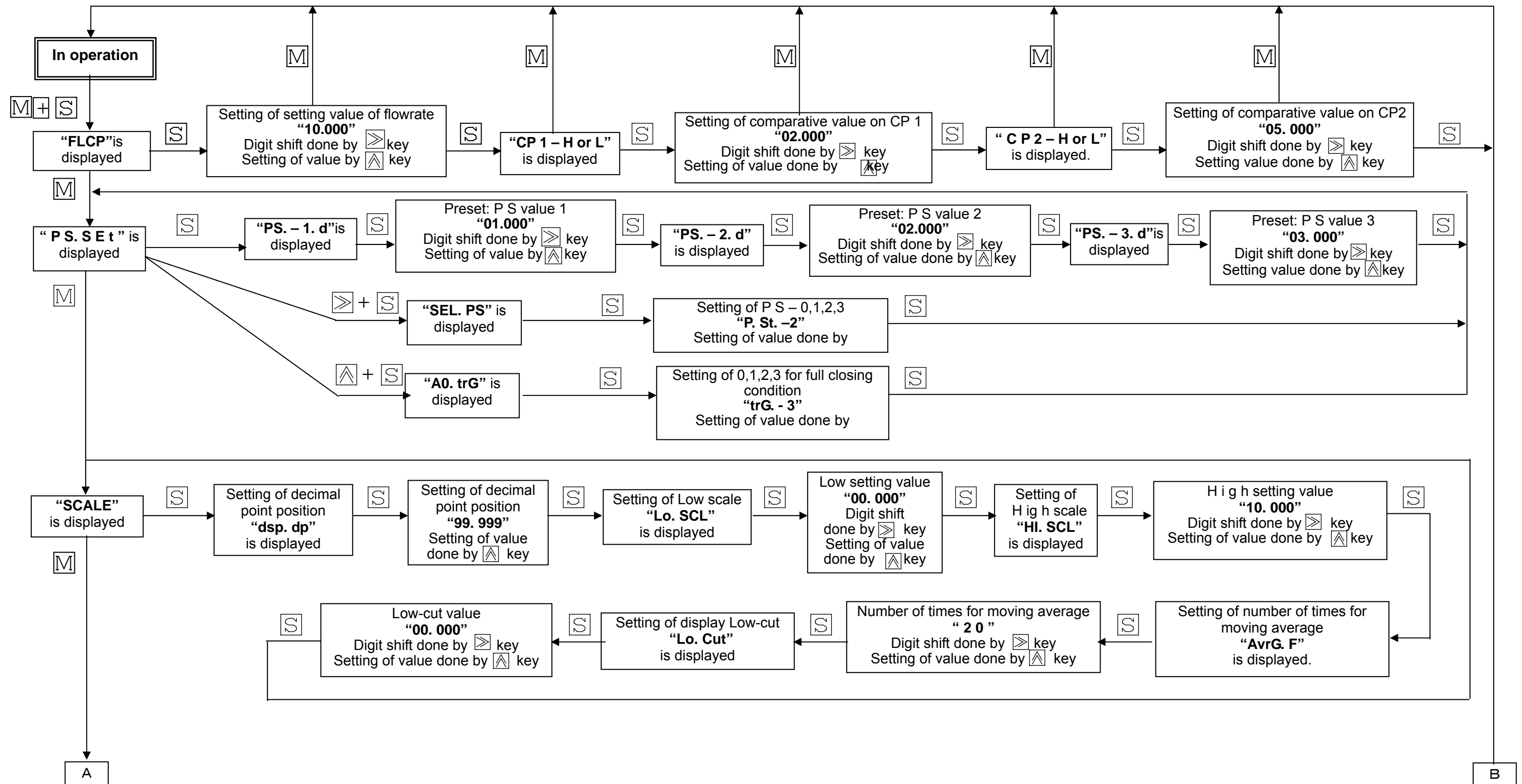

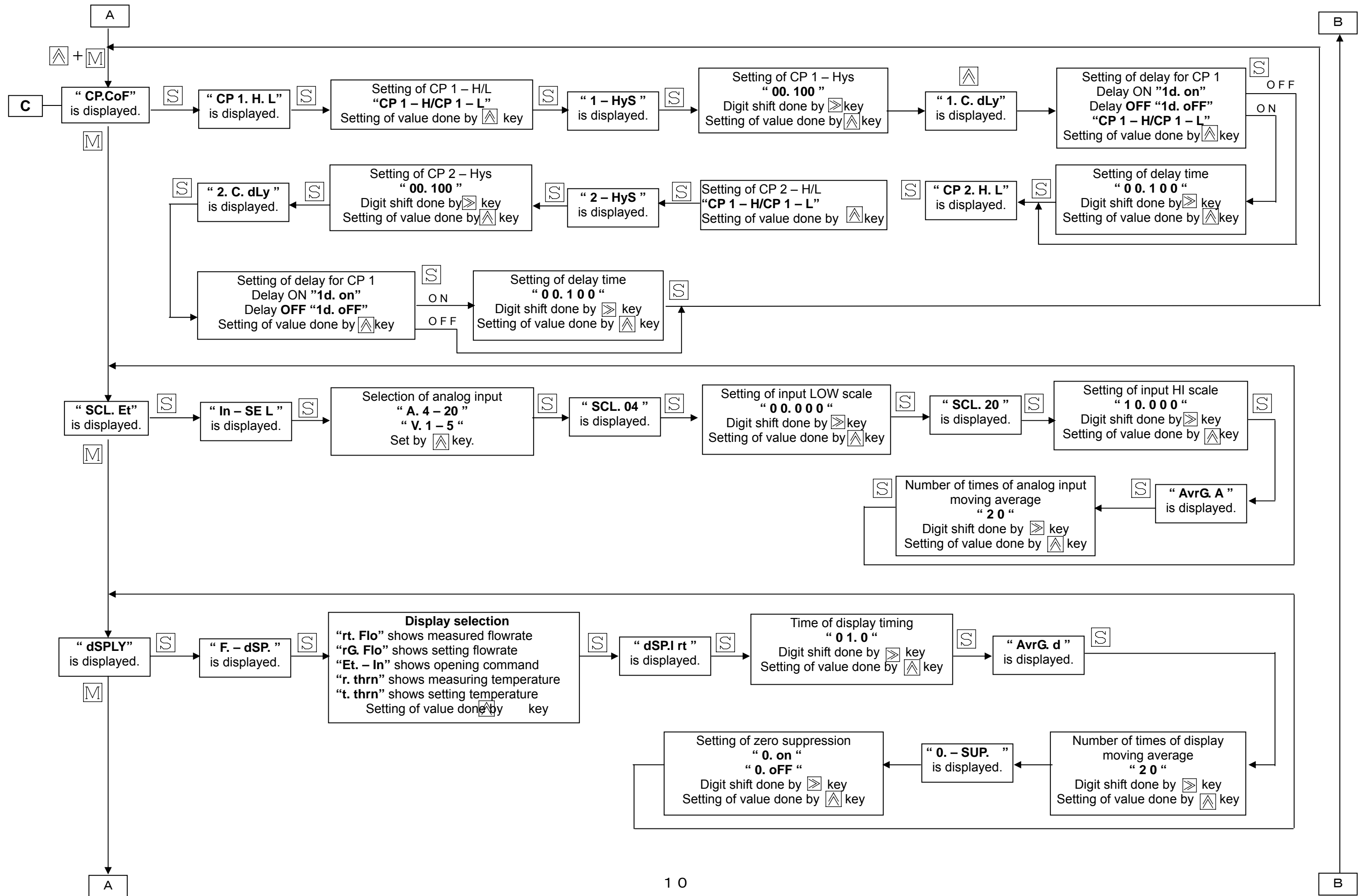

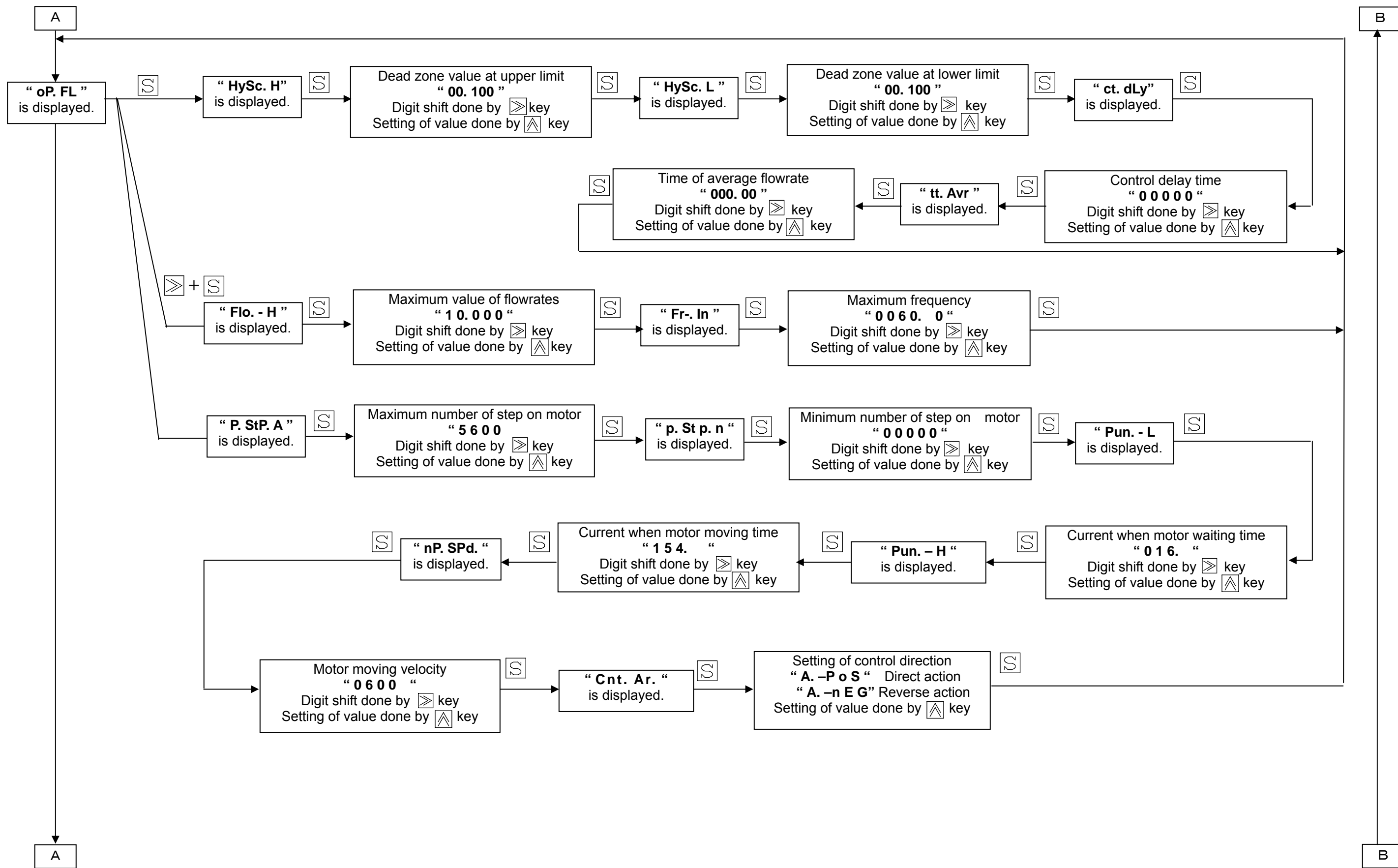

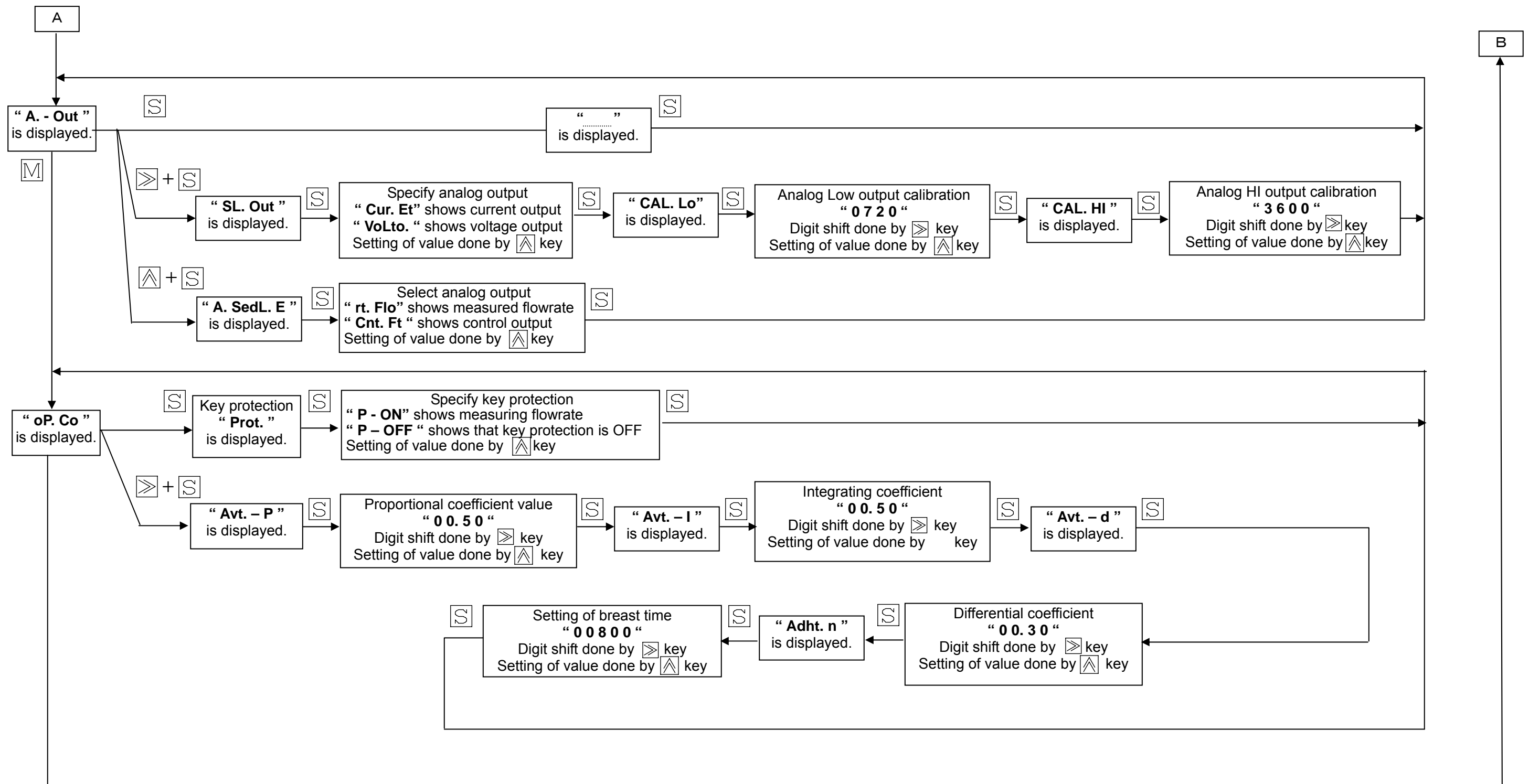

- If pressing **M** key while setting the item within one setting mode, it moves to setting mode next to main loop.
- For changing setting data, they are updated by pressing **S** key after changed the data on display. Even if changed only the data on display and if passed by setting loop by **M** key without pressing **S** key, the previous data remain unchanged as it was.

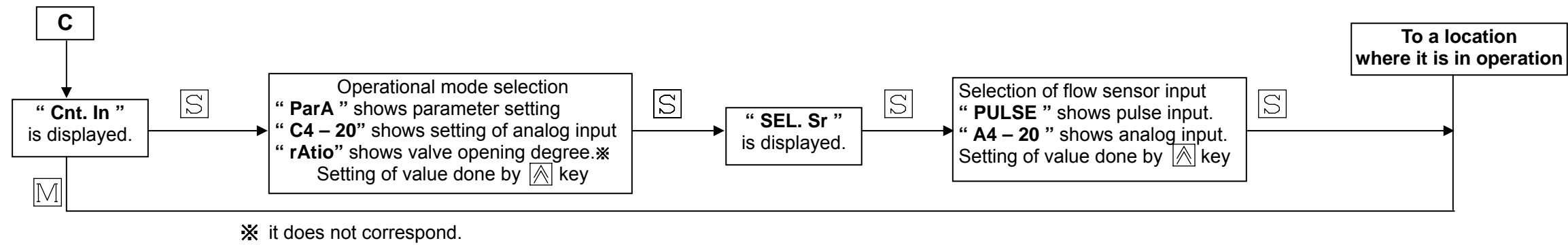

How analog input is calibrated

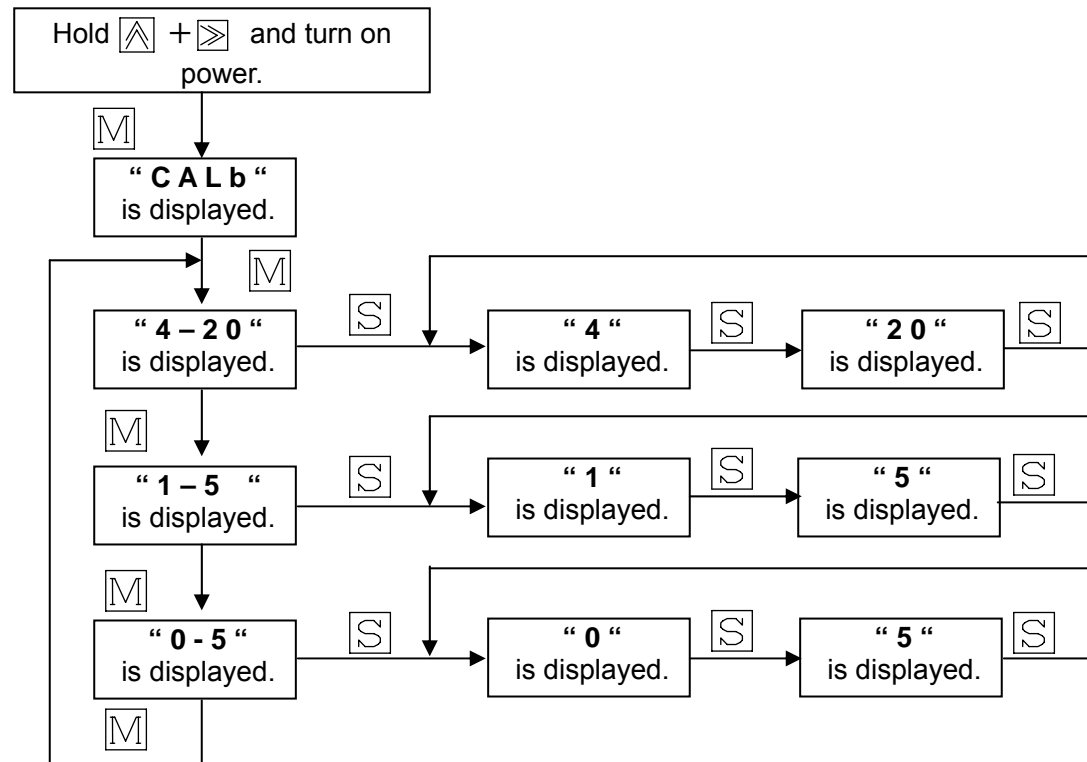

A example for input calibration (when inputting 4-20mA)

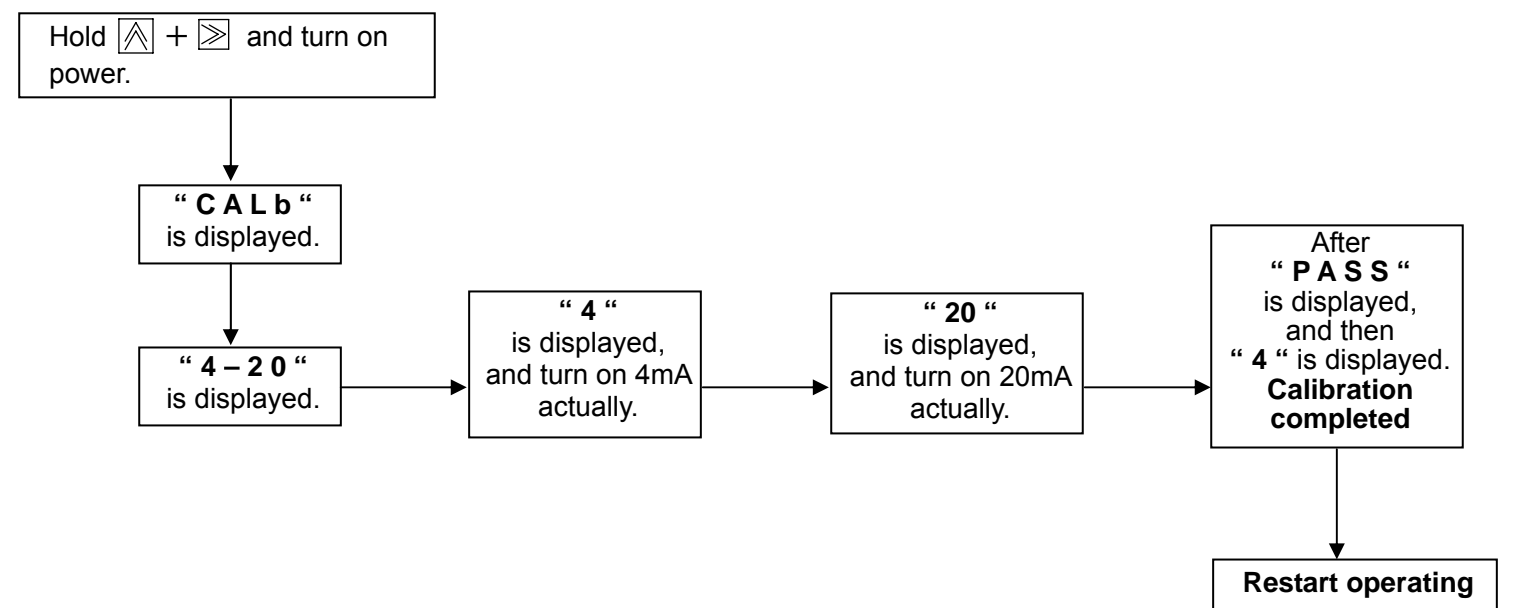

Note: Before calibration, check to ensure that the setting of analog input selection (setting of current and voltage input) has been made properly. (For more details, see on page 8.)
 "A. 4 - 20" . . . Current input (Configured at factory as a standard)
 "V. 1 - 5" . . . Voltage input (When specifying 0 - 5 V / 1 -5 V).
 It is possible to change over the analog input forms. (4-20mA ⇒ 1-5V available to change), but input calibration should be carried out again, when changed over the input form.

Functions of error display

When error occurred, error number is displayed on the screen of the measured values, and it blinks.

Error No.	Contents	Countermeasures and their actions to take
E r 0 2	Backup memory error (Setting value)	Memory which backs up the contents of the settings is failure. It is necessary to repair the hardware.

Trouble shooting (If appeared to have failed, ·····)

Observation	Action	Reference pages
The Controller does not operate.	<ul style="list-style-type: none"> ● Is power switch turned on the Controller ? ● Are the Controller and the valve connected ? (In case of the built-in type) ● Does power supply run normally ? (24VDC and 450mA at max.) ● Has the setting flowrate been set 0 L ? 	P17
The flowrate is not displayed.	<ul style="list-style-type: none"> ● Has the maximum value of flowrate and the frequency (In case of pulse input) been set adequately ? ● Is adequate selection to the sensor input made ? ● Is the display selection made to the “ r t. F L o “ ? ● Are the Controller and valve connected ? (In case of built-in type) 	P5 and 9 P5 and 11 P4 and 8
The setting flowrate cannot be changed.	<ul style="list-style-type: none"> ● Is the operation mode normal ? ● Is the preset terminal turned on or short-circuited ? ● Is the key protection turned on ? ● Does the supply pressure run short ? ● Are the pipes at the primary and secondary sides closed ? 	P5 and 11 P6 and 13 P10
The Controller does not accept an analog input.	<ul style="list-style-type: none"> ● Is the analog input connection made normally ? ● Is the operation mode selection made to “ C 4 – 2 0 “ ? ● Is the analog input selection (Current / voltage) made adequate ? ● Are not the wrong input calibrations carried out ? 	P13 and 14 P11 P4 and 8 P11
Analog output is not produced.	<ul style="list-style-type: none"> ● Is analog input connected normally ? ● Is the analog output designated adequately ? 	P13 and P14 P5 and P10
A stable control cannot be obtained.	<ul style="list-style-type: none"> ● Has the P. I. D. breast time been made adequate ? (Operate it at the initial values ordinarily). ● Is power correct ? (24VDC and 450mA at max. d) ● Is the supply pressure stable in the pipe ? 	P5 and P10 P17
Preset command does not operate properly.	<ul style="list-style-type: none"> ● Is the setting of the preset mode adequate ? ● Has the operational mode selection made to “ P A r A “ ? 	P6 and P7 P5 and P11
Valve is not closed fully.	<ul style="list-style-type: none"> ● Has the setting of the full closing condition been set to “ t r G. – 0 “ ? (Is the full closing function made to OFF ?) ● Are you thinking of trying to hold a full closing in the tentative full closing operation ? (When trying to hold the full closing, 0 L is to be set.) 	P6 and 7 P6

Explanations for external input/output

Rear view of FLC 600

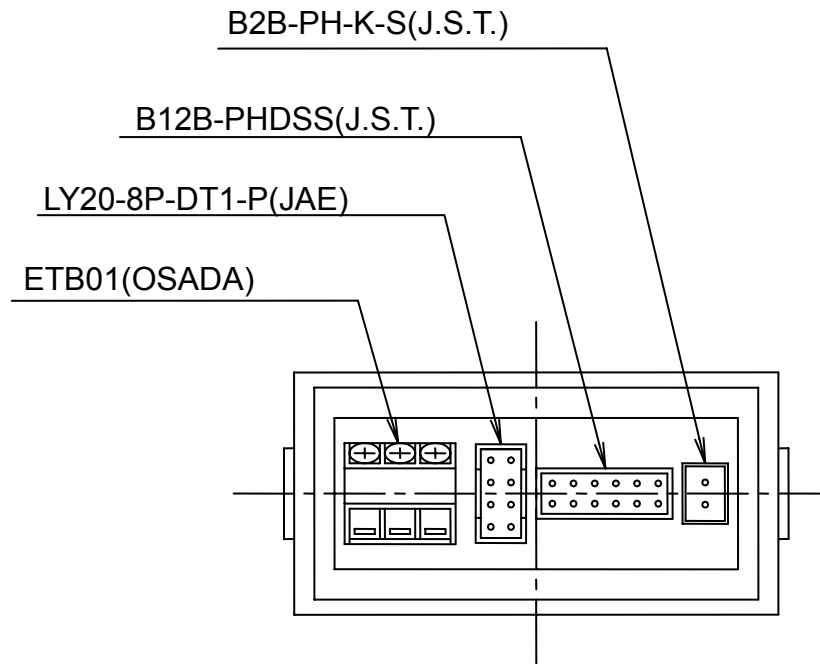

Wiring schematic diagram

C N 4

1	2	3
---	---	---

ETB01 (Made by OSADA)

No.	Connections	
1	Analog input IN	Input H
2		Input L
3	Analog input COM	

C N 3

4B	4A
3B	3A
2B	2A
1B	1A

LY20-8P-DT1-P(Made by JAE)

No.	Connections
1B	Analog output OUT
1A	Analog output COM
2B	Preset 1
2A	Preset COM
3B	Preset 2
3A	Alarm contact CP 1
4B	Alarm contact COM
4A	Alarm contact CP 2

C N 2

1	3	5	7	9	11
2	4	6	8	10	12

B12B-PHDSS(Made by J.S.T.)

No.	Connections
1	Valve COM
2	Valve / A
3	Valve / B
4	Valve A
5	Valve B
6	Valve GND
7	Flowsensor
8	Valve O P 0
9	Flowsensor OUT
10	Valve O P 1
11	Flowsensor V cc
12	Valve +V c

C N 1

2
1

B2B-PH-K-S(J.S.T.)

No.	Connections
1	Power supply at 0VDC
2	Power supply at +24VDC

Nothing has been connected to the pin numbers which are not included. Also do not connect anything to those unoccupied pin numbers.

Wiring



Wiring should be done under the condition that power source is securely turned off. If not, it may cause failure and damage to the devices, or fire.

1. Connecting to power supply

No. 1 and 2 in CN 1 are for connecting to power supply.

- Power supply voltage: 24VDC(±10%)

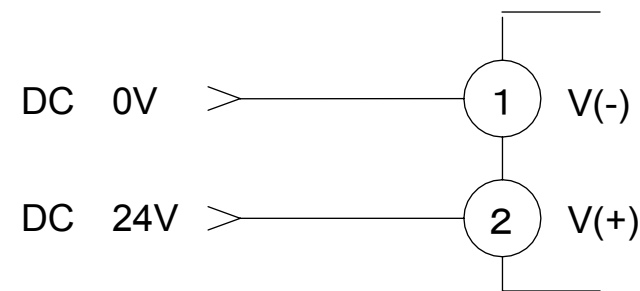

2. Connecting to input signal

No. 1 and 3 in CN 4 are for connecting to input signal.

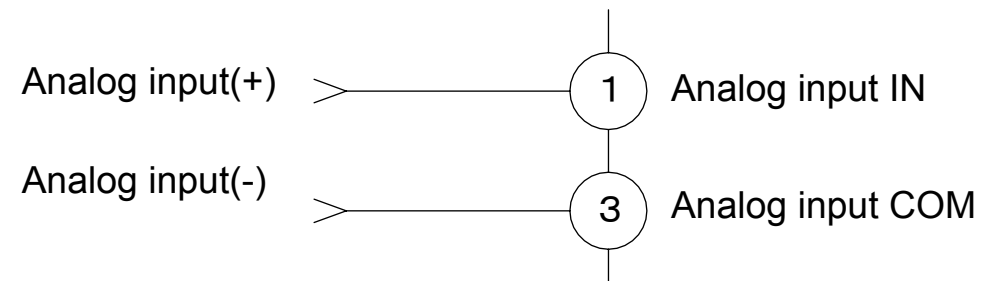

3. Connecting comparative output

No. 6 in CN 3 is for connecting to CP 1 of the comparative output.

No. 8 in CN 3 is for connecting to CP 2 of the comparative output.

- Output impressed voltage : Less than 35VDC, and Sink current : Less than 100mA

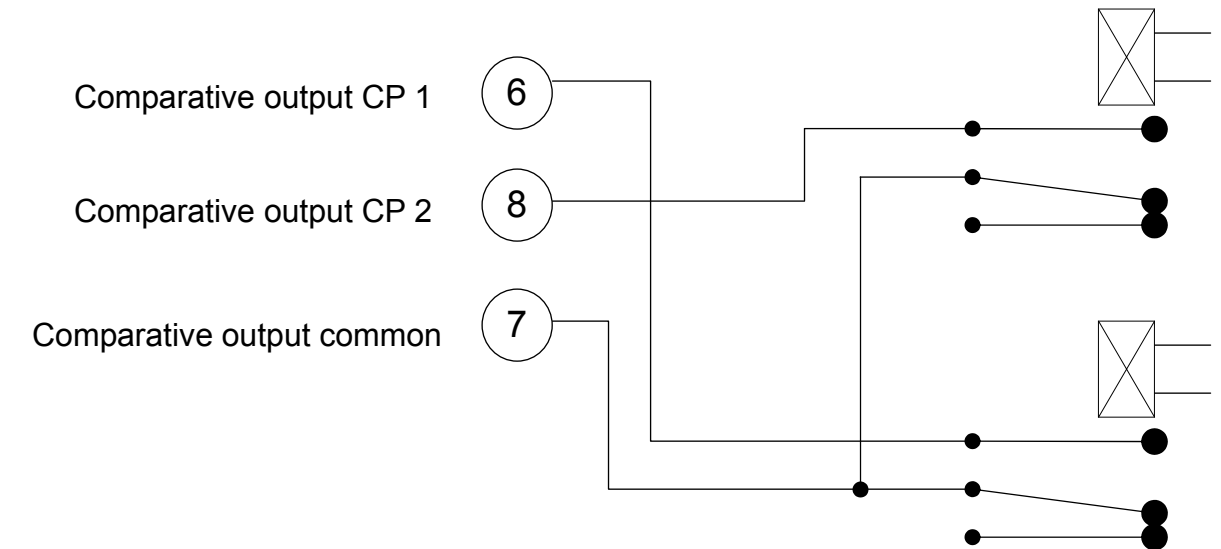

4. Connecting analog output

No. 1 and 2 in CN 3 are for connecting to analog output.

- Load resistance : Less than 300Ω (At the time of outputting 4 – 20 mA)
- Load resistance : More than 1KΩ (At the time of outputting 0 – 5V and 1 – 5 V)

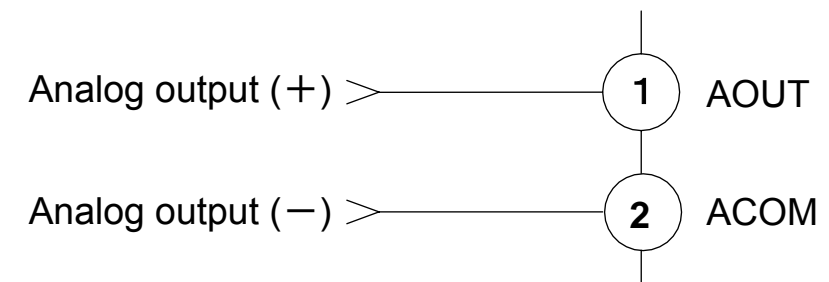

Dimensions for panel cut-out

- Dimensions for panel cut-out

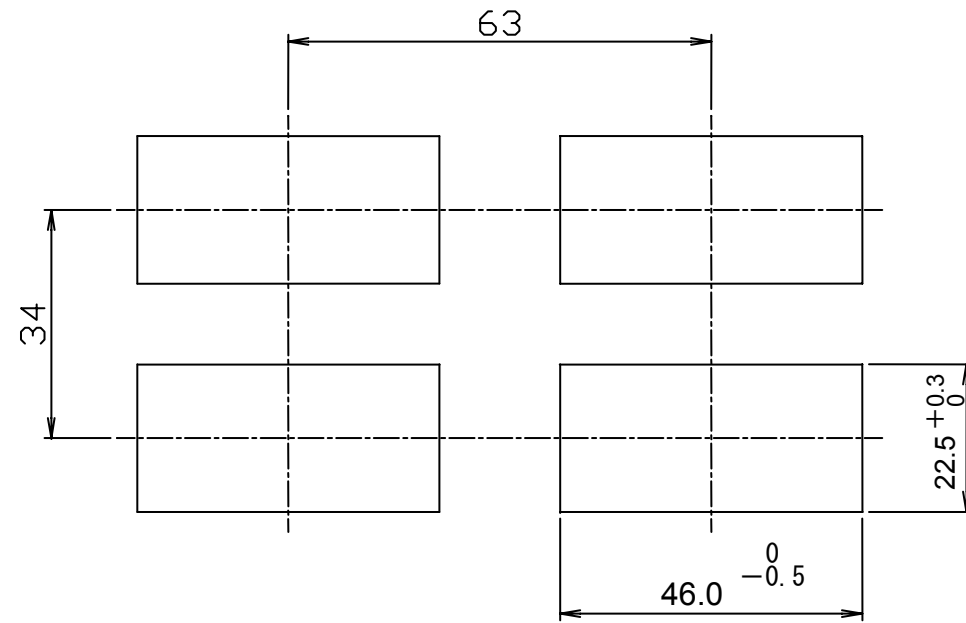

※ Panel in thickness: 0.5mm-4mm

- Panel in depth
Allow 95mm and more panel clearance behind rear for attaching and removing connectors.

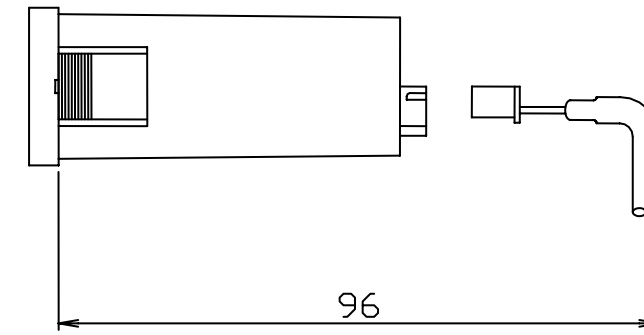

Specifications

1. Measuring input

Items	Conditions	Specifications
Input form	—	Single end input (Isolated from power supply)
Analog input	4 – 20 mA	Input resistance 20Ω
	0 – 5 V	Input resistance 1 MΩ
	1 – 5 V	Input resistance 1 MΩ
Pulse input	—	Open collector input
Allowable excessive input	Analog input	At the time of inputting 4-20mA: 70mA
	Pulse input	15VDC
A – D converter system	Analog input	Double integral system
Pulse measuring form	Pulse input	Periodic measuring form
Periodic measuring sampling	—	0.2 sec. (Sampling time puts off according to input frequency in lower frequency)
Scaling form	Instantaneous value	Digital scaling form In compliance with “Setting of maximum value of flowrate” and “Setting of maximum frequency”.
Max input frequency	Pulse input	Setting ranges: 2 – 300 Hz
Number of times of moving average	Pulse input	Setting ranges: 0 ~ 30 times
Instantaneous value measurement	T _a = +23°C ± 5°C 35 – 85%RH, Setting of scaling for one year (99999)	±0.1% of F.S. ± 1digit (Analog input) ±0.05% of F.S. ± 1digit (Pulse input)
Instantaneous values at temperature drift	T _a = 0 – +50°C	±150ppm of F.S./°C

2. Display

Items	Conditions	Specifications
Display digit number	Instantaneous value display	Five digits (9999) are displayed. Character height: 8 mm by red LED display
Display character height	—	8mm in character height and display by red LED
Comparative output display	Two staged display	Red LED lamp lights up at the time when turning on comparative output.
Display sampling time	—	Setting ranges: 0.2 - 3.0 sec.
Decimal point position in Measured value display	—	Setting position: 9 9 9 . 9 9

3. Comparison

Items	Conditions	Specifications
Comparative operation	Instantaneous value	Two staged alarm output operation at upper and lower limits (Upper/upper limit, upper/lower limit and lower/ lower limit)
Setting of comparative operation	—	Switching over two staged alarm output operation at the upper/lower limits and integrated batch output operation
Setting of comparative value	Instantaneous value	Setting ranges: 000. 00 – 999. 99
Comparative output	—	Relay contact output Kind of contact: One make contact Contact capacity: 35VDC 0.1A Life of contact: More than 100 thousand times Mechanical life: 50 million times

4. Functions

Items	Conditions	Specifications
Memory back up	EEPROM	Backup of each setting data Writable number of times: Approx one million times Storage life: Approx 10 years
Display LOW cut function	—	Setting ranges: 0 – 30. 000
Input signal monitoring function	—	Raw value of signal input is displayed.

5. Analog output

Items	Conditions	Specifications
Analog output	4 – 20mA	Load resistance: Less than 300Ω Resolution: Approx 2500
	0 – 5 V	Load resistance: More than 1KΩ
	1 – 5 V	Resolution: Approx 2500
Analog output accuracy	—	FS ± 0.5%
Temperature drift by analog output	0 – 50 °C	±250 ppm of FS/°C

6. Power supply

Items	Conditions	Specifications
Voltage	—	24VDC ± 10%
Current	24VDC	Approx. 450mA at max.

7. Environment

Items	Conditions	Specifications
Operating temperature	—	0 - +55°C
Operating relative humidity	—	35 - 85%RH (No condensation)
Storage temperature	—	-20 - +70°C

8. Others

Items	Conditions	Specifications
Noise resistance (Impulse)	DC24V VS 0V Power supply VS Panel Panel VS SCOM	Power supply line: 600V (Power supply noise in normal mode) Common mode: 600V (Power supply noise in common mode) Common mode: 600V (Common mode noise)
Withstand voltage	Charging part in block VS Case	500VAC for one minute
Insulating resistance	Power supply VS Alarm output Charging part VS Case	Measured at 500VDC megger. 20MΩ and more
Withstand vibration	—	Number of vibrations: 10 – 55Hz, Double amplitude: 1.5mm X,Y,Z each direction for 2 hours, Sweep time: For one minute (In compliance with JIS-C0911-1984)
Withstand shock	—	Strength of shock: 294m/s ² (Approx 30G) Duration of shock pulse: 11ms X,Y,Z six directions for 3 times (JIS-C0912-1984)
Outside dimensions	—	24H × 48W × approx 65D(mm)
Weight	—	Approx 50g
Case	—	Made from plastic molding

Warranty

- The warranty period of the product shall be one year commencing on the date of delivery.
We will repair or replace any faults occurred during this period which is obviously liable for us at cost of no charge.
- As to how to repair, you are kindly requested to send back the faulty product to our company, and we will undertake to repair or replace the returned products as a take-back repair.
- To avoid processing delay, please be sure to include the memos about the failure content in detail on the product.
- Please understand that the following items shall not be covered by the warranty.
 - Any fault or damage caused by abuse or improperly handling by use side.
 - Any fault or damage caused by other reasons except for cases for which our company is liable.
 - Any fault caused by remodeling or repairing except done by our company.
 - Any fault or damage caused by such disasters as fire, earthquake or flood damage.
 - Any damage triggered by the fault of this product.

《Judgment based on the attached sheet the first to Export Trade Control Ordinance》

This product is an electronic digital indicator which measures the direct-current electricity and voltage. Relating to the said goods above for which we have carefully checked in accordance with a list of the permitted items regulated under control in the attached sheet the first to Export Trade Control Ordinance, we hereby judged that the product are no correspondence items and also that they have no technology regulated under control in ministerial ordinance, and we judged it as goods to be out of strategic goods exporting control.

Judgment: nonrelevant products

Self-judgment date: July 17, 2002



Headquarters: 3-17 Minamidaira, 4-chome Hino City, Tokyo 191-0041

Tel: 81-42-593-8811 / Fax: 81-42-593-8812

Tokyo Sales Office: 3-17 Minamidaira, 4-chome Hino City, Tokyo 191-0041

Tel:81-42-592-6111 / Fax: 81-42-592-6112

Osaka Sales Office: Suite 915, East Exit Station Bldg.

20-14 Higashinakajima, 1-chome Higashiyodogawa ward, Osaka City Osaka-Fu 533-0033

Tel:81-6-4809-0411 / Fax:81-6-4809-0412

Fukuoka Sales Office: 2F K-2 bldg.

8-5 Hakataekiminami, 5-chome Hakata ward, Fukuoka City Fukuoka pref. 812-0016

Tel:81-92-482-2101 / Fax:81-92-482-2102

Sendai Sales Office: Suite 102, Izumi Kankoh bldg.

8-6 Shohgen, 1-chome Izumi ward, Sendai City Miyagi pref. 981-3132

Tel:81-22-218-2451 / Fax:81-22-218-2452