

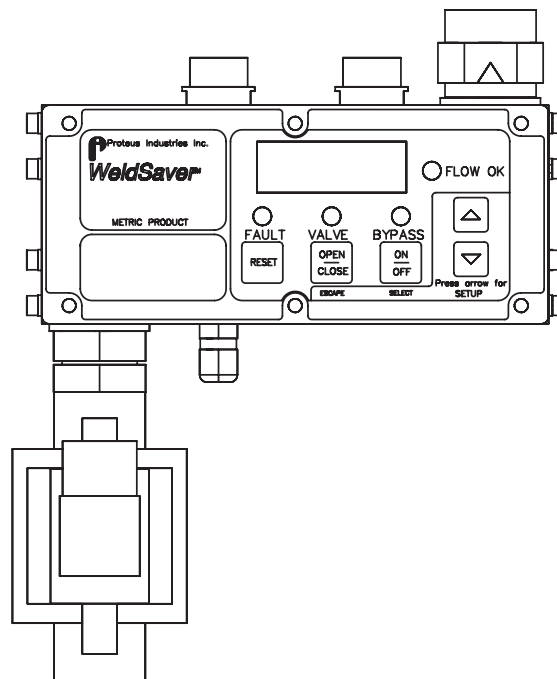

Proteus Industries Inc.

*WeldSaver*TM III

A third generation of excellence in coolant control for robotic welding systems



WS1G11 | WS1G30

Installation and Operating Instructions

Table of Contents

Section	Description	Page
1	Contacts & Cautions	3
2	What It Is & What It Does	4
3	How It Works	6
4	Installation & Testing	7
	4.1 Mechanical Installation & Water Connections	7
	4.2 Electrical Connections	10
	4.3 Three Functionality Tests	12
5	Selecting Control Parameter Values	14
6	Troubleshooting	17
	6.1 Status Faults	17
	6.2 Operating Faults	18
	6.3 WeldSaver Faults	20
7	Dimensional Drawings	23

Technical Support

Proteus Industries Inc.
340 Pioneer Way
Mountain View, CA 94041
Tel: (650) 964-4163
Fax: (650) 965-0304
E-mail: weldsaver@proteusind.com

In the Detroit, MI area, local support is available from:

MJM Sales, Inc.
2660 Auburn Road, Suite 300
Auburn Hills, MI 48326
Tel: (248) 299-0525
Fax: (248) 299-0528



Proteus Industries Inc.
340 Pioneer Way, Mountain View, CA 94041
Tel: (650) 964-4163 Fax: (650) 965-0304
www.proteusind.com sales@proteusind.com

Information in this document was correct at the time of printing; however, specifications are subject to change as Proteus Industries' continuous improvement processes establish new capabilities.

© Proteus Industries Inc.

WS1GUM Rev 002 04/2008

Section 1 : Contacts & Cautions



Purpose

This manual has been created to assist the installation, functional testing and operation of the WS1G11 and WS1G30 versions of the Proteus WeldSaver™. Dimensional drawings and water and power connections are specific to these WeldSaver versions.

If you are attempting to install a different version of the WeldSaver, you may need wiring and connection information specific to that version. Please contact WeldSaver Technical Support for assistance.

Important Safety Information

Throughout this manual, **NOTE**, **CAUTION** and **WARNING** statements are used to highlight important operational and safety information.

NOTE	
	NOTE statements provide details that are important to the successful understanding and application of the system.
CAUTION!	
	CAUTION statements identify conditions or practices that could result in damage to equipment or other property.
WARNING!	
	WARNING statements identify conditions or practices that could result in personal injury or loss of life.

Taking proper precautions to avoid damage to the WeldSaver during installation helps ensure consistent, error-free operation, which lowers costs and assists on-time completion of contracted work.

The safety-related statements inserted in these instructions provide an alert to installers and operators to take sensible steps to allow the WeldSaver to operate correctly the first time and every time.

NOTE	
	<p>Product warranty does NOT cover the repair of installation errors.</p> <p>Proteus WeldSavers are manufactured by ISO 9001 registered processes and are warranted to be free from defects in material and workmanship for 2 years from the date of shipment. The full text of this limited warranty is accessible on the Proteus Industries website at www.proteusind.com/warranty/.</p> <p>The cost of cleaning flow sensors, recalibration or repair of mechanical damage incurred during installation of the product are NOT covered by the warranty.</p> <p>A Purchase Order will be required to allow recovery of such service costs.</p>

Section 2 : What It Is & What It Does

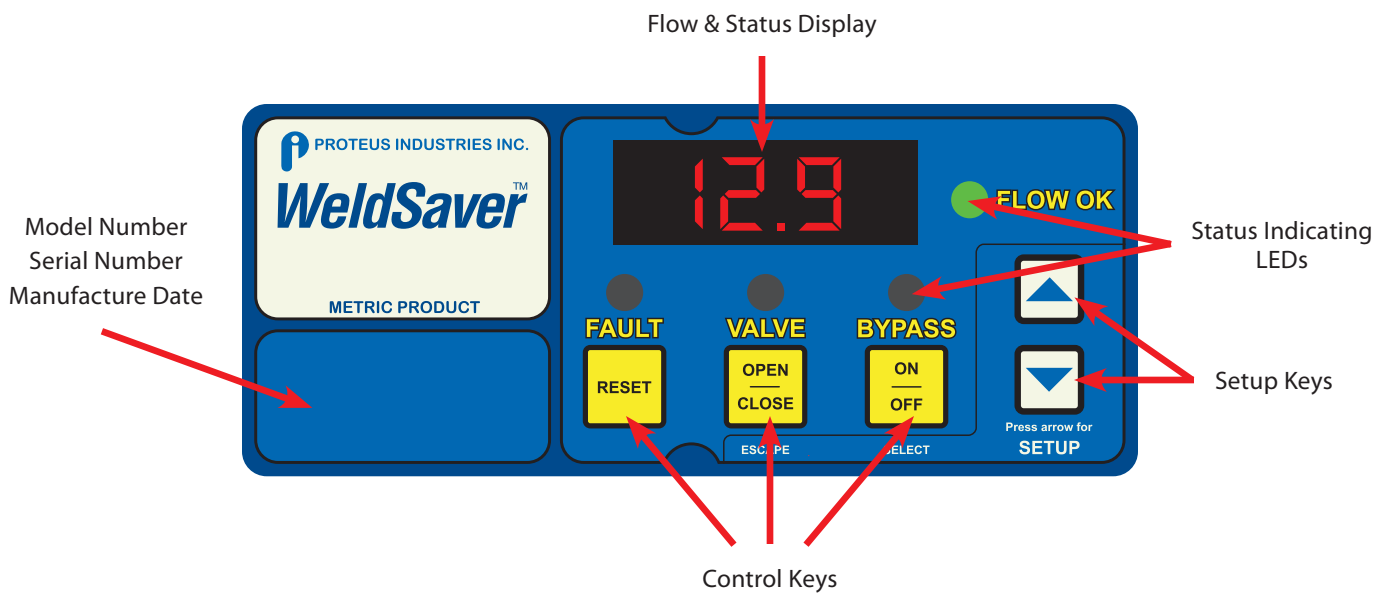
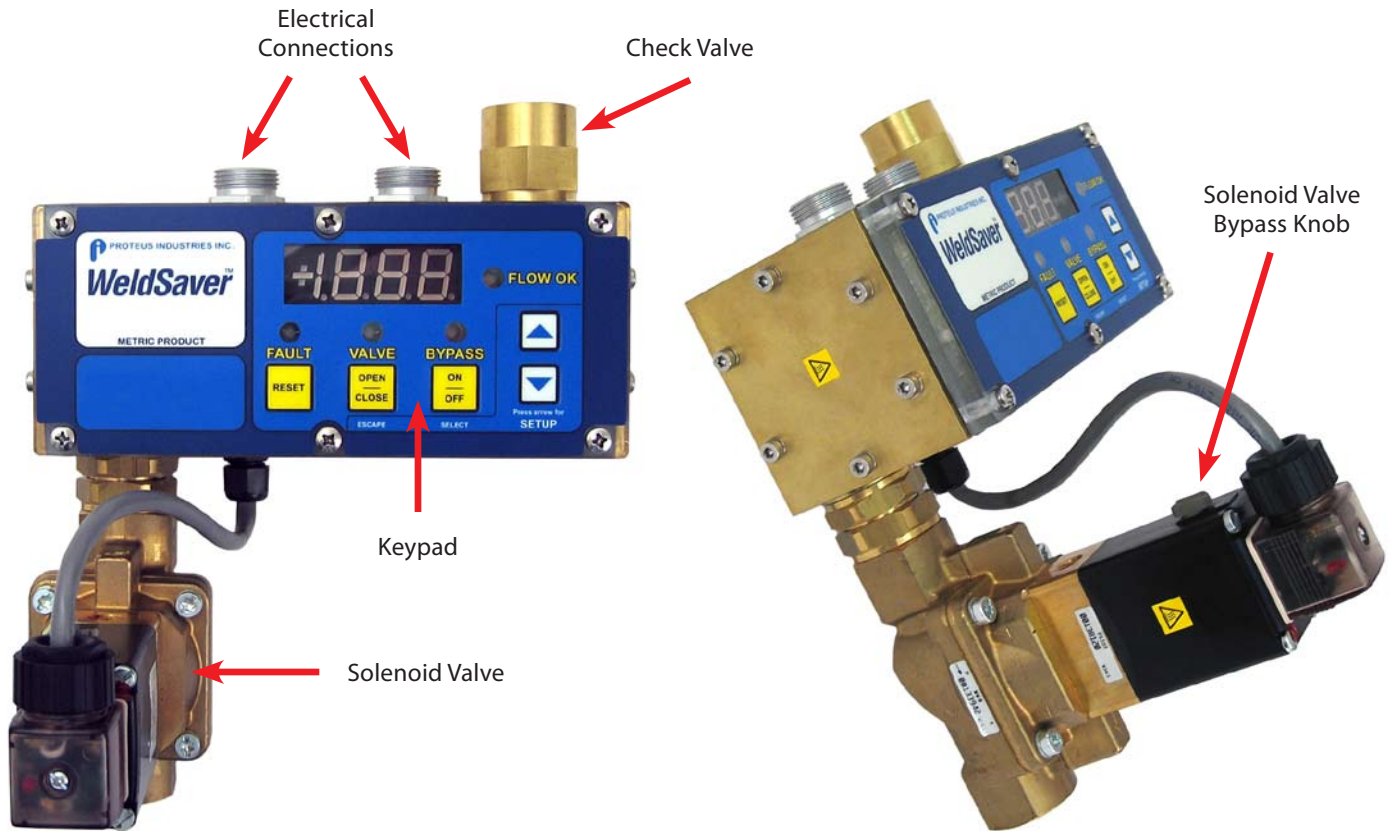
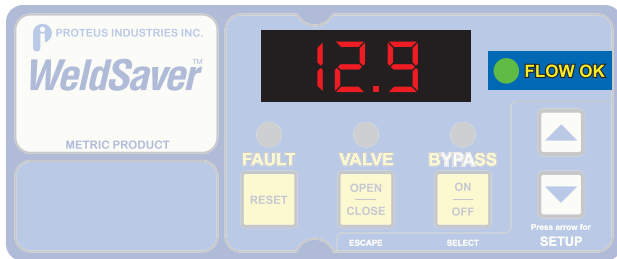

Figure 1: Overview of functional components and keypad of the WS1G WeldSaver

Section 2 : What It Is & What It Does

The Proteus WS1G WeldSaver is a unique water control unit with several advanced capabilities:

■ It's a Flow Meter



The large, bright LED display shows the actual flow rate through the system in LPM (Liters Per Minute) or indicates the flow rate relative to a user-selected Alarm Flow Rate.

■ It's an ON/OFF Flow Valve

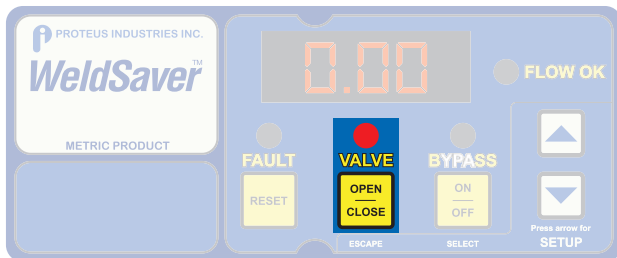

Water flow to the weld cell can be turned ON and OFF using the keypad or remotely from the weld controller.

When the solenoid valve is OPEN, water is flowing and the VALVE status LED is OFF.

When the solenoid valve is CLOSED, water is not flowing and the VALVE status LED is **RED**.

■ It's a Flow Monitor

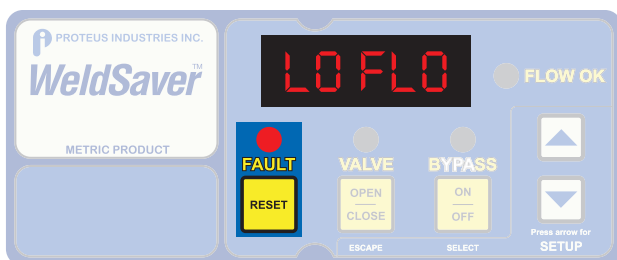

When the flow to the weld cell is greater than the Alarm Flow Rate, the FLOW OK status LED is **GREEN**.

When the flow to the weld cell is less than the Alarm Flow Rate, the FLOW OK status LED is OFF and the FAULT status LED is **RED**.

The **LO FLO** fault message is displayed and the weld controller is instructed to stop the weld program.

■ It's a Very Fast Leak Detector

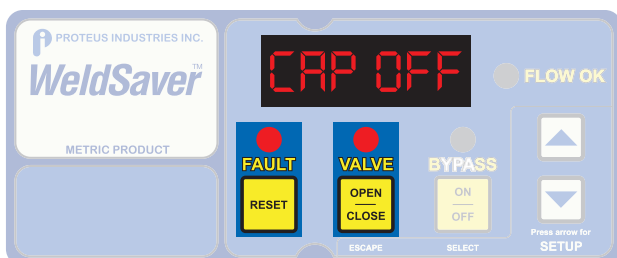

In the event of a weld cap loss, the leak is detected and water flow is shut off in *less than 1 second*.

The **CAP OFF** fault message is displayed and the weld controller is instructed to stop the weld program.

The FAULT and VALVE status LEDs are **RED**.

Section 3 : How It Works

1. Flow Sensing & Measurement

A sensitive and rugged flow sensor is located in both the supply and return coolant lines.

A six-spoke rotor is mounted on a stainless steel shaft in the cylindrical turbine chamber. Coolant enters the turbine chamber through a precision-drilled orifice, causing the rotor to spin at a rate that is directly proportional to the linear velocity of the liquid passing through the chamber.

Magnets located at the end of the rotor spokes turn ON and OFF a Hall Effect sensor located outside the turbine chamber. The frequency output of the Hall Effect sensor is measured by a microcomputer that calculates the flow rate of the liquid.

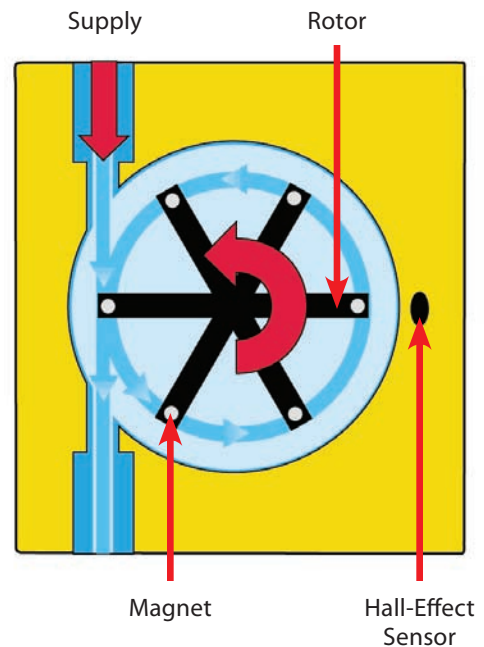

2. Flow Comparison

The measured inlet flow rate is compared with the Fault (OK to Weld) and Alarm flow rates as selected by the operator.

When the measured flow rate is less than the Alarm flow rate, a relay is opened, indicating a **LO FLO** fault condition to the weld controller.

The weld controller makes decisions affecting weld operations based on the flow status reported by the WeldSaver.

3. Cap Loss Detection

The WeldSaver's microcomputer uses a patented algorithm to continuously monitor the output frequencies of both the supply and return flow sensors. This algorithm is able to detect a loss of a weld cap or other catastrophic loss of flow continuity in *less than 0.3 seconds*.

When a cap loss event is detected, the microcomputer shuts off water flow in both the inlet and return lines and a relay is opened, indicating a **CAP OFF** fault condition to the weld controller.

The weld controller makes a decision to shut down weld operations.

Section 4 : Installation & Testing

4.1 Mechanical Installation & Water Connections

- Tools required:
- Adjustable wrenches
 - Pipe wrenches
 - Teflon-based pipe sealant
 - Mounting bolts x 4 to fit #8-32 mounting holes
- OR** M5 x 12 mm screws for units fitted with a mounting bracket

Mechanical Installation

1. Refer to Figure 3 on Page 23 for dimensions and fastening locations.

Flushing, Making & Testing Water Connections

1. Flush the inlet piping.

CAUTION!	
	<p>Flush contaminants and other accumulated construction debris from the upstream water pipe BEFORE connecting the WeldSaver.</p> <p>Failure to flush coolant lines may result in the fouling of the WeldSaver's supply flow sensor and clogging of smaller orifices in the robot supply lines, manifolds and the weld gun.</p>

CAUTION!	
	<p>Flush contaminants and other debris from water lines connecting the robot, manifold, transformer, SCR and any other water-cooled components BEFORE connecting them to the WeldSaver.</p> <p>Failure to flush these lines may result in the fouling of the WeldSaver's return flow sensor and clogging of smaller orifices in the robot supply lines, manifold, transformer, SCR, weld gun and any other water-cooled components.</p>

2. Lubricate threads

Use a lubricating and non-hardening pipe sealant such as Teflon paste on all pipe threads. This material will lubricate G $\frac{3}{4}$ straight-threaded fittings to simplify their installation.

CAUTION!	
	<p>Do NOT allow excess pipe sealant to enter the flow sensors!</p> <p>Excess material may foul the sensors and cause clogging of smaller orifices in the robot's supply lines, manifold, transformer, SCR, weld gun and any other water-cooled components.</p>

Section 4 : Installation & Testing

3. Refer to Figure 2 below to identify the water connection ports.

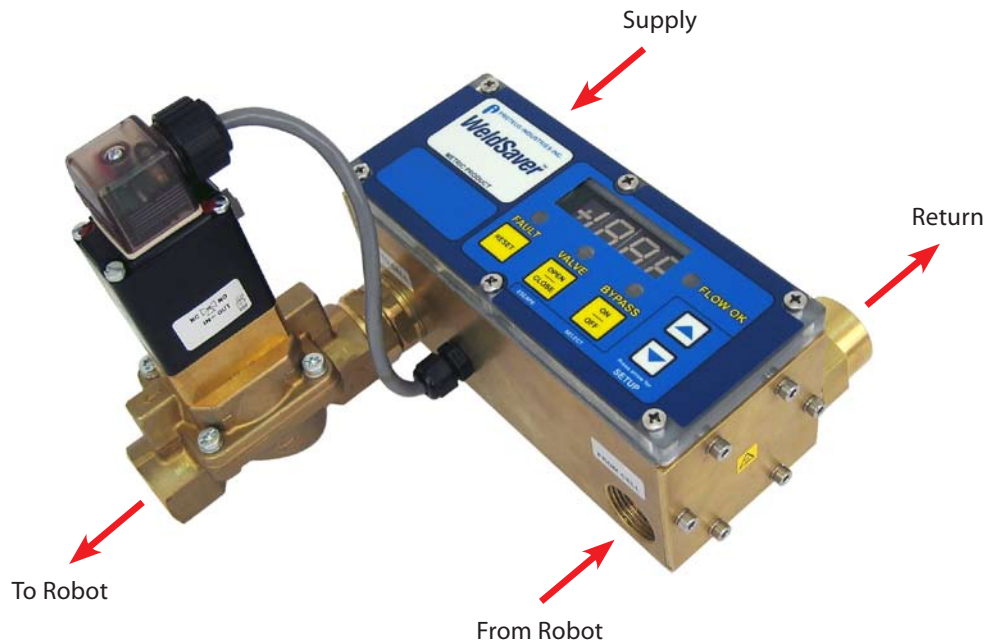



Figure 2: Plumbing connection locations of the WS1G WeldSaver

4. Make plumbing connections to the Supply, Return, To-Robot and From-Robot connection ports on the WeldSaver using the appropriate pipe fittings and sealing washers.

NOTE	
	The WS1G WeldSaver requires G 3/4 metric plumbing connections.

CAUTION!	
	<p>Ensure that the correct hoses have been connected to the To-Robot and From-Robot connections.</p> <p>Check hose labels or trace water flow to confirm that the WeldSaver is connected to include the water circuit cooling the weld gun.</p> <p>If the hose connections are not correct, the WeldSaver may NOT be able to detect the loss of a weld cap.</p>

5. Adjust pipe connections as required for proper alignment of the WeldSaver.

Section 4 : Installation & Testing

- Depress the solenoid valve bypass knob and turn it 90° clockwise to a vertical position to enable flow.

NOTE	
	The WS1G WeldSaver is equipped with a solenoid valve featuring a manual bypass function.

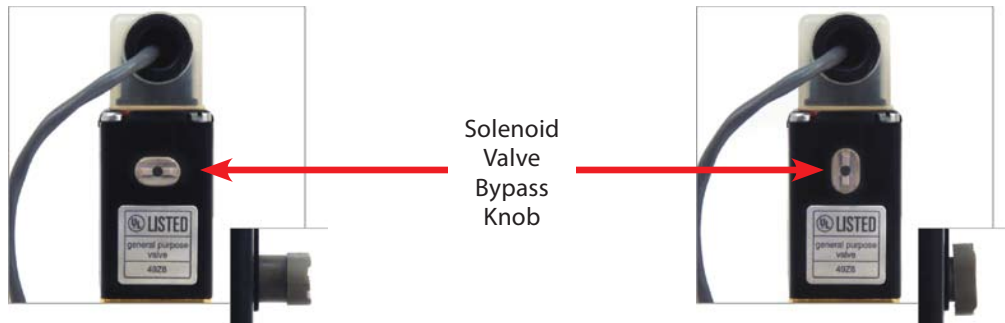

The solenoid valve is functional when the slot in the knob is in a **HORIZONTAL** position.

During normal operation, the solenoid valve enables the control of flow through the system, either locally using the WeldSaver keypad or remotely from the weld controller.

The solenoid valve can be bypassed by depressing the knob and turning it 90° clockwise to a vertical position.

In the manual override state, water can flow through the system to allow leak testing without engaging 24 VDC electrical power.

- Turn water ON slowly.

WARNING!	
	<p>The WeldSaver body is NOT insulated!</p> <p>When using the WeldSaver with hot liquids, use proper personal protective equipment.</p>

- Check for leaks at all connections to the WeldSaver.
- Eliminate all leaks before proceeding.
- Turn the solenoid valve bypass knob 90° counterclockwise and return it to a horizontal position for normal operation.

NOTE	
	If the solenoid valve manual bypass knob is left in a vertical position, the valve will NOT function when power to the WeldSaver is turned on.

Section 4 : Installation & Testing

4.2 Electrical Connections

NOTE	
	The WS1G WeldSaver must be connected to 24 VDC power to perform correctly. Proteus highly recommends connecting the WeldSaver to certified DC power supplies only.

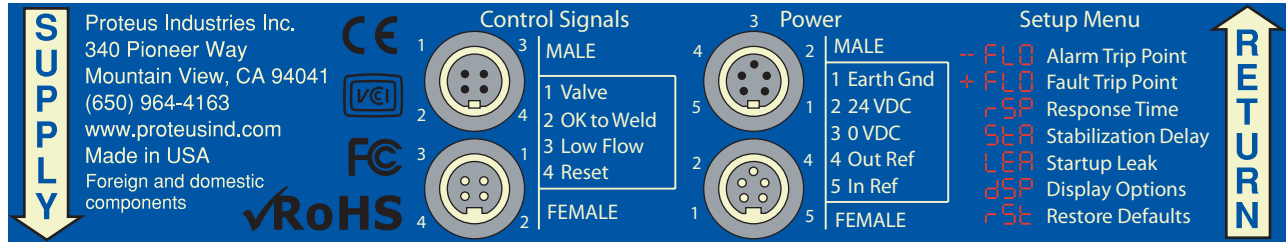



Figure 3: Wiring and electrical connection diagrams for the WS1G WeldSaver

Connecting 24 VDC Power





1. Refer to Figure 3 above to identify the 24 VDC power interface connections.
2. Confirm that the power cable has 24 VDC present between pins 2 and 3 of the 5-pin connector.

CAUTION!	
	Connect the interface cables to the weld controller and the 24 VDC power source BEFORE connecting them to the WeldSaver.

3. Connect the provided cables to the 4-pin and 5-pin connectors on top of the WeldSaver body.

Section 4 : Installation & Testing

Checking Flow Functionality













ACTION	RESULT
<p>1. Turn 24 VDC power ON.</p> <p>Confirm that the DeviceNet controller is operating.</p>	<p>If water is OFF, the display will alternately show 0.00 and the LO FLO fault message.</p>  <p>The diagram shows three stages of the display: 0.00, LO, and FLO. Each stage has a grey circle next to the text 'FLOW OK'. Red arrows connect the stages in a sequence: 0.00 to LO, LO to FLO, and a return arrow from FLO back to 0.00.</p>
<p>2. Turn water flow ON.</p> <p>Press the  key.</p>	<p>If the flow rate is greater than the Alarm / Minimal Flow rate, the actual value will be displayed.</p>  <p>The diagram shows a display with the number '12.9' and a green circle next to the text 'FLOW OK'.</p> <p>If the flow rate is less than the Alarm / Minimal Flow rate, the display will alternately show the actual flow rate and the LO FLO fault message.</p>  <p>The diagram shows three stages of the display: 6.50, LO, and FLO. Each stage has a grey circle next to the text 'FLOW OK'. Red arrows connect the stages in a sequence: 6.50 to LO, LO to FLO, and a return arrow from FLO back to 6.50.</p> <p><i>Flow rates shown are for example only.</i></p>

Section 4 : Installation & Testing





4.3 Three Functionality Tests

To ensure that the WeldSaver is functioning correctly, check the Valve Shut-Off function, the Bypass function and the Cap Off Detection function as described below.

Operational Keys





Desired Function	Action	Status LED	Restore to Normal	Status LED
Clear a FAULT . <i>Restarts water flow and leak detection function.</i>	A fault is detected. The weld program is stopped.	 RED	Press the  key.	 OFF
Turn water ON/OFF .	Press the  key.	 RED	Press the  key again.	 OFF
Select BYPASS mode. <i>BYPASS disables leak detection function only. Flow monitoring is still functional.</i>	Press the  key.	 YELLOW	Press the  key again.	 OFF
Select Operating Parameters	See pages 14–16 for description and selection of control parameters.		 	

Test the Valve Shut-Off Function



ACTION	RESULT	STATUS LED
1. Press the  key.	Water flow is shut OFF. The VALVE status LED will be RED .	 RED
2. Press the  key again.	Water flow is turned ON. The VALVE status LED will be OFF .	 OFF

Section 4 : Installation & Testing

Test the Bypass Function

ACTION	RESULT	STATUS LED
1. Press the  key.	Leak Detection function is turned OFF. The BYPASS status LED will be YELLOW .	
2. Press the  key again.	Leak Detection function is turned ON. The BYPASS status LED will be OFF .	

Test the Cap Off Detection Function

ACTION	RESULT
1. Remove a weld cap and confirm that the Weld-Saver shuts off water flow.	WeldSaver shuts off water flow and displays a CAP OFF fault message. 
2. Reinstall the weld cap. Confirm that the weld cap is properly secured to the weld gun.	
3. Press the  key. <i>Flow rate of 12.9 is shown for example only.</i>	Water flow is restored. WeldSaver displays actual flow rate. 

Section 5 : Selecting Control Parameter Values

STEPS FOR SELECTING CONTROL PARAMETER VALUES

1. Enter SETUP Mode

Press the  or  key to enter **SETUP** mode.

2. Select the Parameter to Adjust

Press the  key to move **DOWN** the stack to the parameter you wish to adjust.

Press the  key to move **UP** the stack to the parameter you wish to adjust.

Press the  **SELECT** key to select the control parameter you wish to change.

The current value of this parameter will be displayed.

The allowable values for each of these parameters are shown in Tables 1 and 2 on pages 15–16.

NOTE



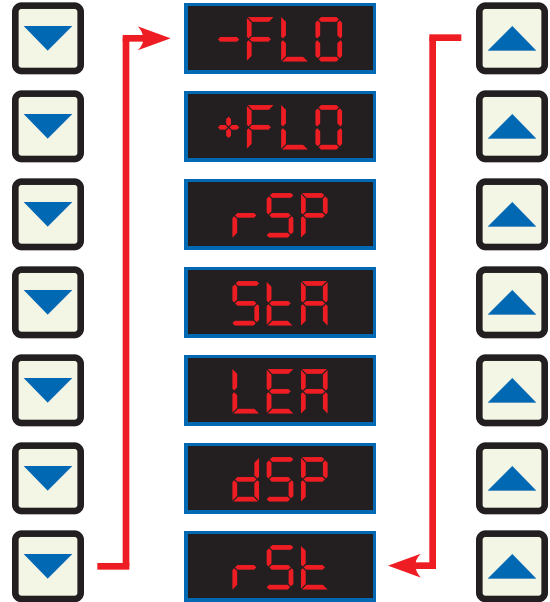

Any parameter you are adjusting will appear at the top of the stack until it has not been changed for 30 minutes. After this time, **-FLO** will appear at the top of the stack.

PARAMETER STACK



3. Adjust the Parameter

Press the  or  key to increase or decrease the value of the selected parameter.

4. Exit SETUP mode

Press the  **SELECT** key to save the selected control parameter value and return to normal operation.

OR

Press the  **ESCAPE** key to return to normal operation **WITHOUT** making or saving any changes.

Section 5 : Selecting Control Parameter Values

Parameter Values for the WS1G11 WeldSaver







STACK SYMBOL	CONTROL PARAMETER					PRESET VALUE	DESCRIPTION & NOTES
Alarm Flow Trip Point							
		LPM				1.5 LPM	This is the lowest flow rate at which the welding system should be operated. Coolant flow lower than this rate does not provide sufficient cooling capacity to allow satisfactory welds to be produced.
	Range	0–11					
	Increments	0.76					
Fault Flow Trip Point							
		LPM				3.0 LPM	This is the flow rate at which the weld system should be operated. This flow rate provides sufficient cooling capacity to allow welds at the desired rate under all ambient temperature conditions.
	Range	0–11					
	Increments	0.76					
Leak Response							
	-SLO	SLO	nOr	FAS	+FAS	nOr	This setting determines how quickly a leak will be detected. Slowing the response reduces sensitivity to false cap-loss events; speeding the response increases sensitivity.
Startup Stabilization Delay Time							
	1 S	2 S	4 S	8 S	16 S	2 Seconds	This setting selects the amount of time required to purge air from the cooling system at startup that could otherwise cause false cap-loss events.
Startup Leak Detection Threshold							
	LPM					1.9 LPM	This setting checks whether the weld cap is properly in place and is not ejected from the weld shank when water pressure is applied. A low setting gives the most sensitive response to the loss of a weld cap at startup; a high setting gives the least sensitive response.
	1.9	3.8	5.7	7.6	9.5		
Absolute or Relative Flow Display							
	AbS	Displays actual flow rate				AbS	The Absolute flow rate is normally used. The Relative displays can be used to check the actual flow against the Alarm or Fault flow rates.
	-rEL	Relative to Alarm flow rate					
	+rEL	Relative to Fault flow rate					
Restore Parameter to Factory Setup Values							
	nO		yES			N/A	This key allows all parameters to be restored to their specified default values.

Table 1: Parameter descriptions, ranges and factory setup values for the WS1G11 WeldSaver

Section 5 : Selecting Control Parameter Values

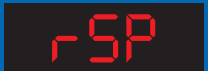
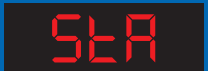
Parameter Values for the WS1G30 WeldSaver







STACK SYMBOL	CONTROL PARAMETER					PRESET VALUE	DESCRIPTION & NOTES	
Alarm Flow Trip Point								
						LPM	This is the lowest flow rate at which the welding system should be operated. Coolant flow lower than this rate does not provide sufficient cooling capacity to allow satisfactory welds to be produced.	
	Range					0–30		7.6 LPM
	Increments					0.76		
Fault Flow Trip Point								
						LPM	This is the flow rate at which the weld system should be operated. This flow rate provides sufficient cooling capacity to allow welds at the desired rate under all ambient temperature conditions.	
	Range					0–30		11.4 LPM
	Increments					0.76		
Leak Response								
	-SLO	SLO	nOr	FAS	+FAS	nOr	This setting determines how quickly a leak will be detected. Slowing the response reduces sensitivity to false cap-loss events; speeding the response increases sensitivity.	
Startup Stabilization Delay Time								
	1 S	2 S	4 S	8 S	16 S	2 Seconds	This setting selects the amount of time required to purge air from the cooling system at startup that could otherwise cause false cap-loss events.	
Startup Leak Detection Threshold								
	LPM					3.8 LPM	This setting checks whether the weld cap is properly in place and is not ejected from the weld shank when water pressure is applied. A low setting gives the most sensitive response to the loss of a weld cap at startup; a high setting gives the least sensitive response.	
	1.9	3.8	5.7	7.6	9.5			
Absolute or Relative Flow Display								
	AbS	Displays actual flow rate				AbS	The Absolute flow rate is normally used. The Relative displays can be used to check the actual flow against the Alarm or Fault flow rates.	
	-rEL	Relative to Alarm flow rate						
	+rEL	Relative to Fault flow rate						
Restore Parameter to Factory Setup Values								
	nO		yES			N/A	This key allows all parameters to be restored to their specified default values.	

Table 2: Parameter descriptions, ranges and factory setup values for the WS1G30 WeldSaver



Section 6 : Troubleshooting

6.1 Status Faults

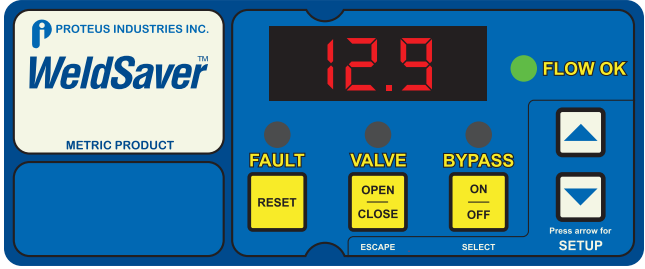
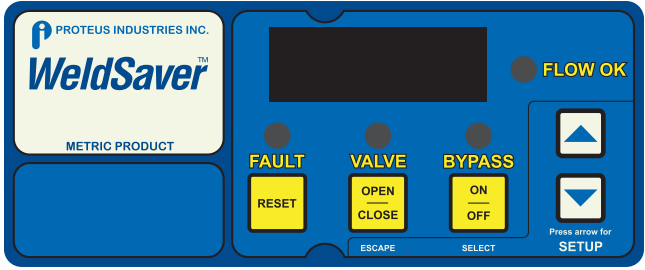
STATUS	KEYPAD INDICATION
<p>STATUS: OK TO WELD</p> <p>NORMAL OPERATING CONDITION</p> <p><i>Flow rate of 12.9 is shown for example only.</i></p>	 <p>● FLOW OK = GREEN</p>
<p>STATUS: NOT OK</p> <p>KEYPAD IS DEAD</p> <ol style="list-style-type: none">1. Check 24 VDC at pins 2 & 3 of the 5-pin connector.2. If 24 VDC is present and the keypad is dead, replace electronics board.	 <p>● FLOW OK = OFF</p>

Section 6 : Troubleshooting

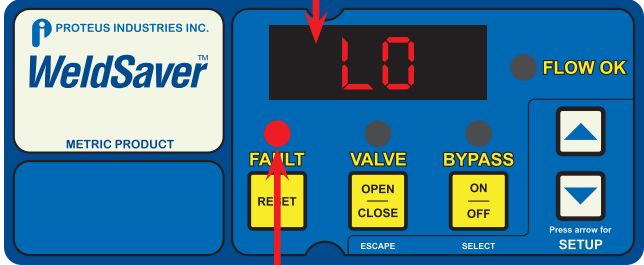
6.2 Operating Faults

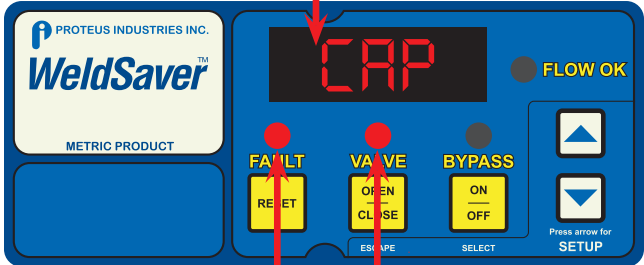
FAULT	KEYPAD INDICATION
<p>LO FLO FAULT</p> <ol style="list-style-type: none"> Flow is less than Alarm flow rate setting <ol style="list-style-type: none"> Check Alarm flow rate setting. Correct If necessary. If Alarm flow rate setting is OK, increase flow rate if possible. If flow rate cannot be increased, reduce Alarm flow rate setting. Rotors are slowed by wear or fouling <ol style="list-style-type: none"> Clean or replace rotors. <p><i>Flow rate of 6.50 is shown for example only.</i></p>	<p>LO FLO ERROR MESSAGE</p> <p>6.50 → LO → FLO</p>  <p>● FAULT = RED</p>
<p>CAP OFF FAULT</p> <ol style="list-style-type: none"> Unit has detected the loss of a weld cap and water flow has been shut off <ol style="list-style-type: none"> Replace weld cap. Press the  key to allow water flow and restart. Welding has stopped, but weld caps are still in place – False cap-loss event <ol style="list-style-type: none"> Change Leak Response setting to SLO or -SLO. Press the  key to allow water flow and restart. Frequent false cap-loss events caused by fouled or worn rotors <ol style="list-style-type: none"> Clean or replace rotors. 	<p>CAP OFF ERROR MESSAGE</p> <p>0.00 → CAP → OFF</p>  <p>● VALVE = RED</p> <p>● FAULT = RED</p>

Section 6 : Troubleshooting

6.2 Operating Faults (Continued)

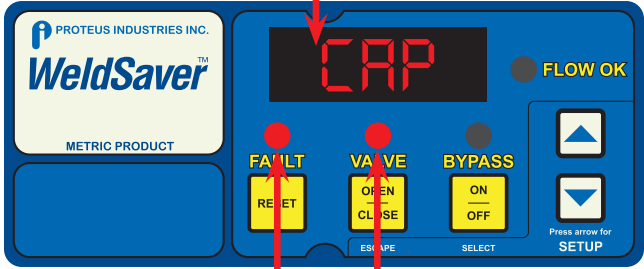
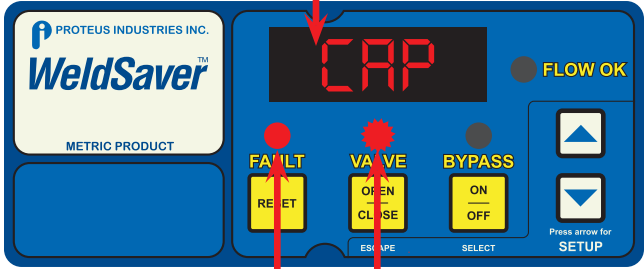
FAULT	KEYPAD INDICATION
<p>JAMMED ROTOR FAULT</p> <p>1. Rotors are jammed or rotating too slowly because of fouling</p> <p>a. Clean or replace rotors.</p> <div data-bbox="196 590 691 768" style="border: 1px solid black; padding: 5px; margin-top: 10px;"> <p style="text-align: center;">NOTE</p> <div style="display: flex; align-items: center;"> <div style="font-size: 2em; margin-right: 10px;">i</div> <p>Flow rate indication is always 0.05 in the event of a Jammed Rotor Fault.</p> </div> </div>	<p style="text-align: center;">CAP OFF ERROR MESSAGE</p> <p style="text-align: center;">0.05 → CAP → OFF</p>  <p style="text-align: center;">● VALVE = RED</p> <p style="text-align: center;">● FAULT = RED</p>
<p>VALVE FAULT</p> <p>VALVE status LED flashes at 1-second intervals; flow rate indication does not go to 0.00 as solenoid valve is not able to shut off water flow.</p> <p>1. Solenoid valve is fouled</p> <p>a. Clean or replace solenoid valve.</p> <p>2. There is not sufficient back pressure to close solenoid valve</p> <p>a. Increase back pressure to greater than 5 kPa / 7.25 psi.</p> <p style="font-size: small; margin-top: 10px;"><i>Flow rate of 2.72 is shown for example only.</i></p>	<p style="text-align: center;">CAP OFF ERROR MESSAGE</p> <p style="text-align: center;">2.72 → CAP → OFF</p>  <p style="text-align: center;">● VALVE = FLASHING RED</p> <p style="text-align: center;">● FAULT = RED</p>

Section 6 : Troubleshooting



6.3 WeldSaver Faults

■ PROBLEM : WELDSAVER DOES NOT DETECT CAP OFF CONDITION

1. Unit is in BYPASS mode

- a. Press the  key to return to normal operation.

2. Leak Response setting is TOO SLOW



- a. Enter setup mode and select the  function.
- b. Press the  key to select a faster response.
- c. Press the  key to save the new value and return to normal operation.

3. Rotors are slowed by wear or fouling

- a. Clean or replace rotors.
-



■ PROBLEM : WELDSAVER DOES NOT DETECT CAP LOSS IMMEDIATELY AFTER RESET

1. Startup Leak Detection Threshold setting is TOO HIGH

- a. Enter setup mode and select the  function.
- b. Press the  key to select a lower value.
- c. Press the  key to save the new value and return to normal operation.
-

■ PROBLEM : A LO FLO OR CAP OFF FAULT IS DETECTED IMMEDIATELY AFTER REPLACING A WELD CAP

1. Startup Stabilization Delay setting is TOO SHORT

- a. Enter setup mode and select the  function.
- b. Press the  key to select a longer delay.
- c. Press the  key to save the new value and return to normal operation.
-

Section 6 : Troubleshooting

6.3 WeldSaver Faults (Continued)

■ PROBLEM: WELDSAVER DOES NOT SHUT OFF WATER FLOW

1. Solenoid valve manual override is engaged
 - a. Turn solenoid valve manual bypass knob 90° counterclockwise to disengage (See Page 9).
 2. Solenoid valve pilot flow is blocked
 - a. Clean or replace solenoid valve.
 3. Check valve is blocked or fouled
 - a. Clean or replace check valve.
-

■ PROBLEM: A LO FLO FAULT IS DETECTED WHEN SUFFICIENT FLOW IS PRESENT

1. Rotors are fouled
 - a. Clean or replace rotors.
-



■ PROBLEM: FLOW RATE DISPLAY IS ERRATIC

1. Rotors are fouled
 - a. Clean or replace rotors.
-

■ PROBLEM: FLOW RATE REDUCES OVER TIME

1. Filter is clogged
 - a. Clean or replace filter.
-

■ PROBLEM: FALSE CAP OFF FAULTS OCCUR REPEATEDLY AT THE SAME STEP IN THE WELD CYCLE WHEN RAPID ROBOT MOVEMENT OCCURS

1. Leak Response setting is TOO FAST
 - a. Enter setup mode and select the  function.
 - b. Press the  key to select a slower response.
 - c. Press the  key to save the new value and return to normal operation.

Section 6 : Troubleshooting

6.3 WeldSaver Faults (Continued)

■ **PROBLEM: FALSE CAP OFF EVENTS OCCUR WITH REGULARITY**

1. Rotors are fouled
 - a. Clean or replace rotors.
-

■ **PROBLEM: NO WATER FLOW IS PRESENT
FLOW RATE INDICATION DISPLAYS 0.00
VALVE STATUS LED IS RED**

1. Valve is CLOSED
 - a. Press the  key to open the valve.

Section 7 : Dimensional Drawings

Front View

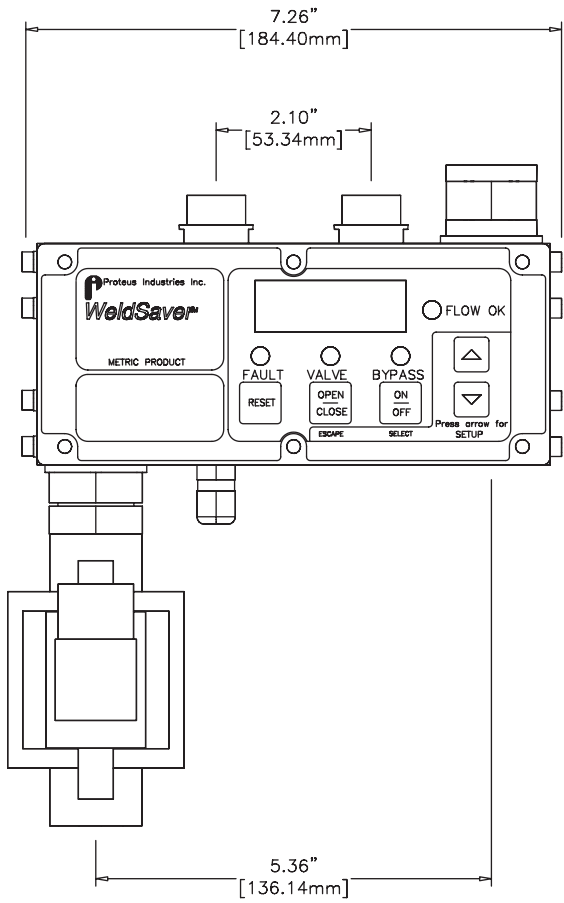

Rear View

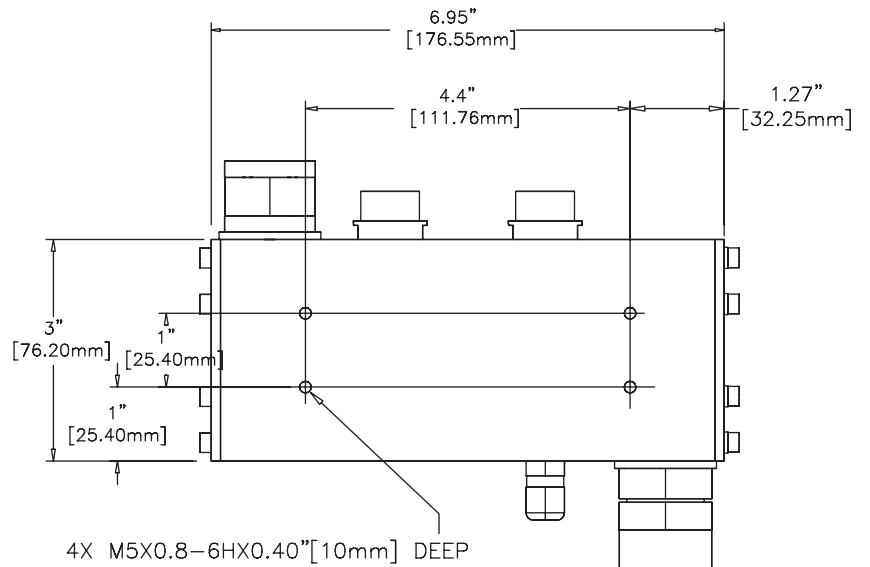

Right Side View

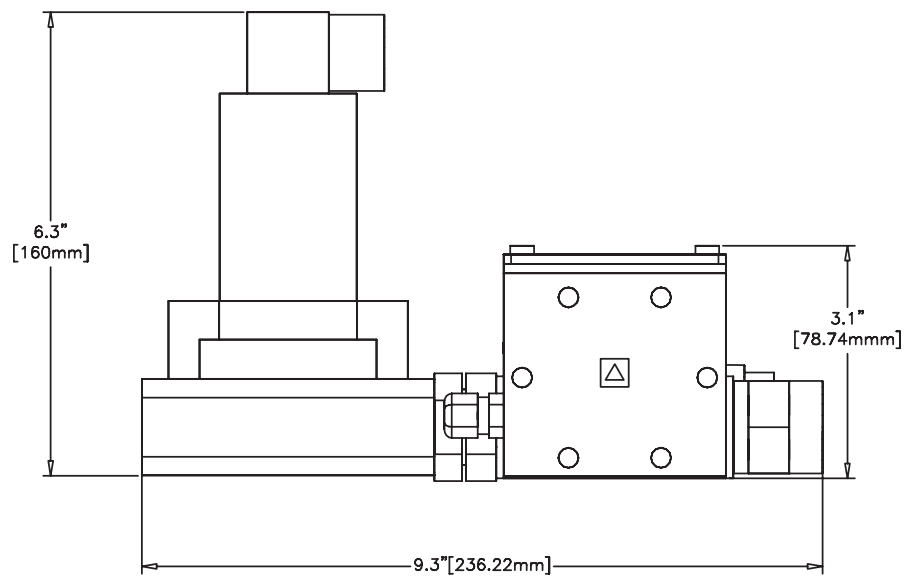

Figure 3: Dimensions of the WS1G WeldSaver